

1 Türgarnituren



1

2 Diverse Türbeschläge



2

3 Griffe für Fenster und Fenstertüren



3

4 Diverse Fensterbeschläge



4

5 Bänder und Zierhülsen



5

6 Diverse Baubeschläge



6

7 Innenausbau



7

8 Möbelbeschläge



8

9 Zubehör

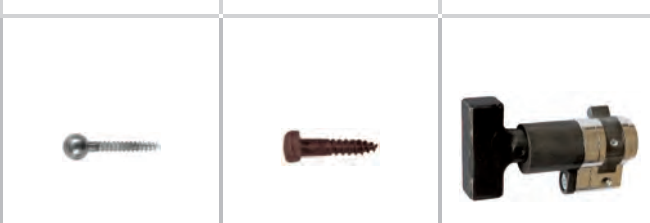

9

Bestell-Nr.	Seite	Bestell-Nr.	Seite	Bestell-Nr.	Seite	Bestell-Nr.	Seite	Bestell-Nr.	Seite
13.100	1.06	13.1285	8.10	13.1741	8.15	13.320	5.10	13.435	8.07
13.100H	1.06	13.1289	8.10	13.1750	8.04	13.324 A	5.11	13.436 Z	8.08
13.101	1.06	13.1291	8.10	13.1752	8.04	13.324	5.11	13.440	4.04
13.101H	1.06	13.1292	8.10	13.1755	8.11	13.325 B	5.11	13.441	4.04
13.1026	8.02	13.1295	8.11	13.1757	8.11	13.325 D	5.11	13.443	4.04
13.105	1.10, 1.13	13.1299	8.11	13.1759	8.16	13.325	5.11	13.444/495	3.10
13.1112	8.15	13.1301	8.11	13.1768	8.15	13.327 B	5.12	13.444/763 CR	3.12
13.1121	8.15	13.132	1.07	13.181/499	3.05	13.327	5.12	13.444/763 DK-FR	3.12
13.1125 S	8.16	13.133	1.07	13.181	1.11	13.328	5.12	13.445	4.04
13.1125	8.16	13.1350	8.03	13.182	1.11	13.332 A	5.13	13.446/493	3.10
13.1130	8.16	13.1351	8.03	13.183	1.11	13.332 B	5.08, 5.13	13.447/493	3.10
13.1134	8.08	13.1352	8.03	13.184/495	3.05	13.332 C	5.13	13.448/493	3.10
13.1137	8.08	13.1360	8.03	13.184	1.12	13.332 D	5.08, 5.13	13.449/492	3.11
13.1176	5.05	13.1365	8.03	13.184H	1.12	13.332	5.13	13.449/495	3.11
13.1177	5.05	13.140	1.12	13.184HS/187K	3.09	13.333 A	5.14	13.450	3.11
13.1178	5.06	13.140K	1.05	13.185/496	3.05	13.333 B	5.14	13.451	3.11
13.1180	5.06	13.141	1.07	13.185	1.04	13.333 C	5.14	13.452	3.11
13.1181	5.06	13.142/493	3.02	13.186 STG	4.02	13.333 D	5.14	13.454/499	3.11
13.1185	8.12	13.142/496	3.02	13.186/495	3.05	13.333 E	5.14	13.456/495	3.12
13.1186	8.12	13.142	1.02, 1.08	13.186	1.05-1.06, 1.12	13.333 F	5.14	13.457/495	3.12
13.1188	8.12	13.142H	1.02, 1.08	13.186H	1.05, 1.12	13.333	5.14-5.15	13.458	8.08
13.1200 B	8.13	13.142HFW	1.02	13.186HS/187K	3.09	13.334 M	5.15	13.459/493	3.12
13.1200 D	8.13	13.142HS/147K	3.07	13.187	1.12	13.334	5.15	13.480 D1	3.15
13.1200	8.13	13.143/493	3.02	13.187H	1.12	13.340	6.02	13.480 RK GK	3.15
13.1202 B	8.13	13.143/496	3.02	13.187K	1.06	13.341	6.02	13.480 RK	3.15
13.1202 D	8.13	13.143	1.03, 1.08	13.188/496	3.06	13.342	6.03	13.488/498	3.12
13.1202	8.13	13.144/493	3.03	13.188/498	3.06	13.343	6.03	13.493 STB	4.03
13.1208 B	8.14	13.144/494	3.03	13.188	1.05-1.06, 1.13	13.345	6.03	13.493H I	4.02
13.1208 D	8.14	13.144	1.03, 1.08	13.188H	1.05, 1.13	13.346	6.03	13.494 SV	3.06
13.1208	8.14	13.144H	1.03, 1.08	13.188HS/191K	3.10	13.360	6.04	13.495 I	4.02
13.1210 B	8.14	13.144HS/147K	3.07	13.191	1.13	13.361	6.04	13.495 STB	4.03
13.1210 D	8.14	13.145/493	3.03	13.191H	1.13	13.365	6.04	13.495 VR	4.02
13.1210	8.14	13.145/494	3.03	13.191K	1.06	13.366	6.04	13.496 SV	3.06
13.1212	8.15	13.145	1.03, 1.09	13.192/493	3.06	13.385	6.06	13.498 STB	4.03
13.1213	8.15	13.146/493	3.04	13.194	1.13	13.386	6.06	13.498H I	4.02
13.1214	8.15	13.146	1.04-1.05, 1.09	13.197	1.02-1.05	13.387	6.05	13.498H VR	4.02
13.1218	8.04	13.1465	5.02	13.198	1.05	13.388	6.06	13.499 I	4.02
13.122	1.07	13.1466 C	5.02	13.200	1.03	13.395	2.03	13.499 STB	4.03
13.1220	8.04	13.1466 HR	5.03	13.205	1.02, 1.04	13.396	2.03	13.608	7.04
13.1223	8.04	13.1468	5.03	13.205H	1.02, 1.04	13.397	2.03	13.615	7.02
13.1224	8.04	13.146H	1.04, 1.09	13.211	2.02	13.398	2.03	13.620	7.02
13.1225	8.04	13.146HFW	1.04	13.211H/200 B	2.02	13.400 B1	4.05	13.630	7.02
13.1226	8.04	13.146HS/147	3.08	13.211H	2.02	13.400 B2	4.05	13.631	7.02
13.1227	8.05	13.147	1.08-1.09	13.214/214 B	2.02	13.400 D1	4.05	13.632	7.03
13.1228	8.05	13.1470	5.02	13.214	2.02	13.400 D2	4.05	13.633	7.03
13.123	1.07	13.1471 C	5.02	13.217/217 B	2.02	13.400/140	4.05	13.700	2.04
13.1230	8.05	13.1471 HR	5.03	13.217	2.02	13.400/210	4.05	13.709	3.06
13.1231	8.05	13.1473	5.03	13.219/198	2.02	13.401 D1	4.05	13.717	3.14
13.1233	8.05	13.1474	5.04	13.219	2.02	13.401/140	4.05	13.718	3.14
13.1234	8.05	13.1475	5.02	13.220/205 B	2.03	13.402 B	4.05-4.06	13.720	3.14
13.1235	8.05	13.1476 C	5.02	13.220	2.02	13.402 D	4.05-4.06	13.722	3.14
13.1236	8.05	13.1476 HR	5.03	13.224	2.06	13.402/190	4.05-4.06	13.723	3.14
13.1237	8.06	13.1478	5.04	13.228	2.05	13.402/230	4.06	13.724	3.14
13.1238	8.06	13.1479	5.04	13.230	2.05	13.403 B	4.06	13.726	3.14
13.1239	8.06	13.147H	1.08-1.09	13.249	6.05	13.403 D	4.06	13.760 D1	3.15
13.1240	8.06	13.147K	1.05	13.250	6.05	13.403/240	4.06	13.760 D2	3.16
13.1241	8.06	13.148/493	3.04	13.251	6.05	13.406 B	4.07	13.760 D3	3.16
13.1245	8.06	13.148	1.04, 1.09	13.252	6.05	13.406 D	4.07	13.760 EK R	3.17
13.1246	8.06-8.07	13.1482	5.04	13.256	2.04	13.406/190	4.07	13.760 EK S	3.17
13.1248	8.02	13.1486	5.04	13.257	2.04	13.407 B	4.07	13.760 EKH E	3.17
13.1250	8.02	13.1488	5.05	13.259	2.04	13.407 D	4.07	13.760 EKH Q	3.17
13.1252	8.02	13.1489	5.05	13.270/K	6.02	13.407/230	4.07	13.760 RK GK	3.17
13.1253	8.02	13.148HS/147K	3.08	13.270/W	6.02	13.421	4.03	13.760 RK S	3.17
13.1254	8.02	13.149	1.13	13.270	6.02	13.422	4.03	13.760 RK	3.17
13.1255	8.02	13.1500	8.11	13.301 A	5.07	13.424	4.03	13.760 RKH GK	3.18
13.1256	8.02	13.1506	8.11	13.301	5.07	13.425	4.03	13.760 RKH	3.18
13.1257	8.03	13.1510	8.12	13.304 B	5.07	13.426	4.04	13.760 UP	3.18
13.1258	8.03	13.152	1.10	13.304	5.07	13.427	4.04	13.763 EF	3.13
13.1260	8.08	13.160	1.10	13.305 B	5.08	13.428	4.04	13.763 EK	3.13
13.1261	8.08	13.161	1.10	13.305 D	5.08	13.429	8.07	13.763 EU	3.13
13.1262	8.09	13.168/499	3.04	13.305	5.08	13.430 Z	8.07	13.763 MF	3.13
13.1276	8.09	13.168	1.10	13.306	5.08	13.430	8.07	13.763 ST	3.13
13.1278	8.09	13.170/499	3.04	13.308	5.09	13.431	8.07	13.765	7.05
13.1280	8.09	13.170	1.11	13.315	5.09	13.432	8.07	13.766	7.05
13.1282	8.09	13.171	1.11	13.316	5.10	13.434	4.04	13.767	7.05

Bestell-Nr.	Seite	Bestell-Nr.	Seite	Bestell-Nr.	Seite	Bestell-Nr.	Seite	Bestell-Nr.	Seite
13.768	7.05	15.1476 HR	5.16	15.332 A	5.20	15.565	4.16	16.1478	5.23
13.769	7.05	15.1478	5.17	15.332 B	5.20	15.568	4.16	16.1479	5.23
13.770 M	7.05	15.1479	5.17	15.332 C	5.20	15.620	7.08	16.147HS/147K	3.34
13.770	7.06	15.147H	1.17–1.18	15.332 D	5.20	15.800	7.08	16.148/493	3.30
13.773 M	7.06	15.148/493	3.20	15.332	5.20	15.820	7.08	16.148	1.22, 1.24
13.773	7.06	15.148	1.15, 1.18	15.333	5.20	15.821	7.08	16.1482	5.24
13.774	7.06	15.1482	5.18	15.334 M	5.21	15.822	7.08	16.1486	5.24
13.775	7.06	15.1486	5.18	15.334	5.21	15.823	7.09	16.148HS/147K	3.34
13.776	7.06	15.1488	5.18	15.341	6.09	15.826	7.09	16.1500	8.23
13.777 A	7.07	15.148HS/147K	3.25	15.380	6.09	15.827	7.09	16.168/499	3.31
13.777	7.07	15.152H	1.18	15.382	6.09	15.828	7.09	16.184/495	3.31
13.778	7.07	15.160H	1.19	15.386	6.09	15.834	7.10	16.184	1.25
13.779	7.07	15.161H	1.19	15.395	2.08	15.836	7.10	16.184HS/187K	3.35
13.780	7.07	15.168/499	3.21	15.396	2.08	15.837	7.10	16.186/495	3.31
13.781 A	7.07	15.170H	1.19	15.397	2.08	15.838	7.11	16.186	1.22, 1.25
13.781	7.07	15.171H	1.19	15.398	2.08	15.850	6.09	16.186HS/187K	3.35
13.782	7.07	15.184/495	3.21	15.402 B	4.09	16.1159	8.23	16.187	1.25
13.783	7.07	15.184	1.19	15.402 D	4.09	16.1168	8.23	16.188/496	3.31
13.787	7.03	15.184H	1.19	15.402/190	4.09	16.1180	5.24	16.188/498	3.32
13.790	7.03	15.184HS/187K	3.26	15.424	4.08	16.1181	5.24	16.188	1.22, 1.25
13.791	7.03	15.186/495	3.21	15.430 Z	8.18	16.1200 D	8.24	16.188HS/191K	3.36
13.792	7.03	15.186	1.15, 1.20	15.430	8.18	16.1200	8.24	16.191	1.25
13.793	7.03	15.186G/495	3.22	15.444/495	3.28	16.1202 B	8.24	16.197	1.21–1.22
13.794	7.04	15.186H	1.15, 1.20	15.445	4.08	16.1202 D	8.24	16.198	1.22
13.795	7.04	15.186HS/187K	3.26	15.446/493	3.28	16.1202	8.24	16.200	1.21
13.797	7.04	15.186N/495	3.22	15.447/493	3.28	16.1218	8.19	16.205	1.21–1.22
13.798	7.04	15.187	1.19–1.20	15.448/493	3.28	16.1220	8.20	16.211	2.10
13.799	7.04	15.187H	1.19–1.20	15.457/495	3.28	16.1223	8.20	16.211H/200 B	2.10
13.800	7.04	15.188/496	3.21	15.474	3.23	16.1224	8.20	16.211H	2.10
13.850	6.06	15.188/498	3.22	15.475	3.23	16.1226	8.20	16.219	2.10
13.851	6.06	15.188	1.16, 1.20	15.476	3.23	16.1227	8.20	16.220/205 B	2.10
13.914	7.02	15.188H	1.16, 1.20	15.488/498	3.28	16.1228	8.20	16.220	2.10
13.915	7.02	15.188HS/191K	3.27	15.493H A	4.08	16.1230	8.20	16.250	6.10
13.916	7.02	15.191	1.20	15.493H I	4.08	16.1233	8.20	16.256	2.11
15.100H	1.16	15.191H	1.20	15.494 SV	3.22	16.1234	8.21	16.259	2.11
15.101H	1.16	15.194H	1.20	15.495 A	4.08	16.1236	8.21	16.270/K	6.10
15.105H	1.18, 1.20	15.197	1.14, 1.16	15.495 I	4.08	16.1238	8.21	16.270/W	6.10
15.1224	8.17	15.198	1.15	15.495 VR	4.08	16.1250	8.19	16.270	6.10
15.1226	8.17	15.200	1.14–1.15	15.496 SV	3.22	16.1252	8.19	16.305 B	5.25
15.1228	8.17	15.205	1.14–1.15	15.498H A	4.08	16.1256	8.19	16.305 D	5.25
15.1230	8.18	15.205H	1.14–1.15	15.498H I	4.08	16.1257	8.19	16.305	5.25
15.1234	8.18	15.211	2.07	15.498H VR	4.08	16.1260	8.22	16.324 A	5.25
15.1252	8.17	15.211H/200 B	2.07	15.500	4.09	16.1276	8.22	16.324	5.25
15.1256	8.17	15.211H	2.07	15.502	4.12	16.1280/60 R	8.22	16.325 B	5.25
15.1301	8.18	15.213	2.07	15.503	4.10	16.1280	8.22	16.325 D	5.25
15.132H	1.16	15.213H/203 B	2.07	15.506.1	4.10	16.1295	8.23	16.325	5.25
15.133H	1.16	15.213H	2.07	15.506.2	4.10	16.1299	8.23	16.332 A	5.26
15.1350	8.17	15.219/198	2.07	15.507	4.13	16.1301	8.23	16.332 B	5.26
15.1351	8.17	15.219	2.07	15.510 A	4.13	16.132	1.23	16.332 C	5.26
15.1352	8.17	15.220/205 B	2.08	15.512	4.14	16.133	1.23	16.332 D	5.26
15.142/493	3.19	15.220	2.08	15.513	4.14	16.1350	8.19	16.332	5.26
15.142/496	3.19	15.225	2.09	15.514	4.11	16.1351	8.19	16.341	6.10
15.142	1.14, 1.17	15.226	2.09	15.515	4.11	16.1352	8.19	16.395	2.10–2.11
15.142H	1.14, 1.17	15.228	2.09	15.516	4.10	16.142/493	3.29	16.396	2.11
15.142HS/147K	3.24	15.239	6.07	15.517	4.13	16.142/496	3.29	16.397	2.11
15.144/493	3.19	15.240	6.07	15.518	4.11	16.142	1.21, 1.23	16.398	2.11
15.144/494	3.19	15.241	6.07	15.519	4.13	16.142HS/147K	3.33	16.402 B	4.18
15.144	1.14, 1.17	15.246	6.08	15.520	4.11	16.144/493	3.29	16.402 D	4.18
15.144H	1.14, 1.17	15.247	6.08	15.522	4.14	16.144/494	3.29	16.402/190	4.18
15.144HS/147K	3.24	15.250	6.09	15.524	4.12	16.144	1.21, 1.23	16.424	4.17
15.145/493	3.20	15.256	2.08	15.533	4.14	16.144HS/147K	3.33	16.429	8.21
15.145/494	3.20	15.259	2.09	15.534	4.14	16.145/493	3.30	16.430 Z	8.21
15.145	1.15, 1.17	15.270/K	6.08	15.550	4.14	16.145/494	3.30	16.430	8.21
15.146/493	3.20	15.270/W	6.08	15.551	4.12	16.145	1.21, 1.24	16.435	8.21
15.146	1.15, 1.18	15.270	6.08	15.552	4.14	16.146/493	3.30	16.436 Z	8.22
15.146H	1.15, 1.18	15.272	7.08	15.553	4.12	16.146	1.21, 1.24	16.441	4.17
15.146HS/147	3.25	15.273	7.08	15.554	4.12	16.147	1.23–1.24	16.444/495	3.37
15.147	1.17–1.18	15.305 B	5.19	15.555	4.14	16.1470	5.22	16.446/493	3.37
15.1470	5.16	15.305 D	5.19	15.556	4.15	16.1471 C	5.22	16.447/493	3.37
15.1471 C	5.16	15.305	5.19	15.557	4.15	16.1471 HR	5.22	16.448/493	3.37
15.1471 HR	5.16	15.324 A	5.19	15.560	4.15	16.1473	5.23	16.449/492	3.37
15.1473	5.17	15.324	5.19	15.561	4.15	16.1474	5.23	16.451	3.37
15.1474	5.17	15.325 B	5.19	15.562	4.15	16.1475	5.22	16.452	3.37
15.1475	5.16	15.325 D	5.19	15.563	4.15	16.1476 C	5.22	16.456/495	3.38
15.1476 C	5.16	15.325	5.19	15.564	4.15	16.1476 HR	5.22	16.457/495	3.38

Bestell-Nr.	Seite	Bestell-Nr.	Seite
16.458	8.22	80.301	8.27
16.488/498	3.38	80.310	8.27
16.493H I	4.17	80.340	8.27
16.494 SV	3.32	80.350	8.27
16.495 I	4.17	80.352	8.27
16.495 VR	4.17	80.360	8.27
16.496 SV	3.32	80.380	8.27
16.498H I	4.17	80.820	7.13
16.498H VR	4.17	80.823	7.13
16.615	7.12	80.824	7.13
16.620	7.12	80.825	7.13
16.790	7.12	80.826	7.14
16.791	7.12	80.827	7.14
16.792	7.12	80.828	7.14
16.850	6.11	83.1044	1.32–1.33
18.1122 F	8.25	83.1052H/1052H	2.12
18.1122 W	8.25	83.1103/1562	3.43
18.1122	8.26	83.1103	1.30, 1.32
18.1127	8.25	83.1103HS/1047	3.45
18.1159	8.25	83.1135/1562	3.43
18.1160	8.25	83.1135	1.30, 1.32
18.1164	8.25	83.1135HS/1047	3.45
18.1168	8.25	83.1138/1562	3.43
18.1169	8.25	83.1138	1.30, 1.32
18.1170	8.25	83.1138HS/1047	3.46
18.274	7.12	83.1139/1562	3.43
18.424	4.18	83.1139	1.30, 1.33
60.1982.16	9.03	83.1139R/1562	3.44
60.1983.16	9.03	83.1139R	1.31, 1.33
60.1984.16	9.03	83.1144/1562	3.44
60.2950.13	9.02	83.1144	1.31, 1.33
60.2950.15	9.03	83.1155/1561	3.44
60.3201.13	9.02	83.1155	1.31
60.3201.15	9.02	83.1180	1.32
60.3201.16	9.04	83.1294/1561	3.44
60.3203.13	9.02	83.1294	1.31
60.3203.16	9.04	83.1323	2.12
60.3208.13	9.02	83.1538	1.30–1.31
60.3208.15	9.03	83.1548	1.31
60.3208.16	9.04	83.1851	6.11
60.3213.15	9.03	83.300	8.28
60.4275.18	9.04	83.301	8.28
60.4277.13	9.02	83.310	8.28
60.4278.13	9.02	83.340	8.28
60.4279.18	9.04	83.350	8.28
60.4285.14	9.02	83.352	8.28
60.4285.16	9.03	83.360	8.28
60.4286.13	9.02	83.380	8.28
80.1044	1.28–1.29	83.820	7.15
80.1052H/1052H	2.12	83.823	7.15
80.1103/1562	3.39	83.824	7.15
80.1103	1.26, 1.28	83.825	7.15
80.1103HS/1047	3.41	83.826	7.16
80.1135/1562	3.39	83.827	7.16
80.1135	1.26, 1.28	83.828	7.16
80.1135HS/1047	3.41		
80.1138/1562	3.39		
80.1138	1.26, 1.28		
80.1138HS/1047	3.42		
80.1139/1562	3.39		
80.1139	1.26, 1.29		
80.1139R/1562	3.40		
80.1139R	1.27, 1.29		
80.1144/1562	3.40		
80.1144	1.27, 1.29		
80.1155/1561	3.40		
80.1155	1.27		
80.1180	1.28, 1.32		
80.1294/1561	3.40		
80.1294	1.27		
80.1323	2.12		
80.1538	1.26–1.27		
80.1548	1.27		
80.1851	6.11		
80.300	8.27		

DIN links

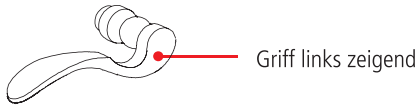

DIN rechts

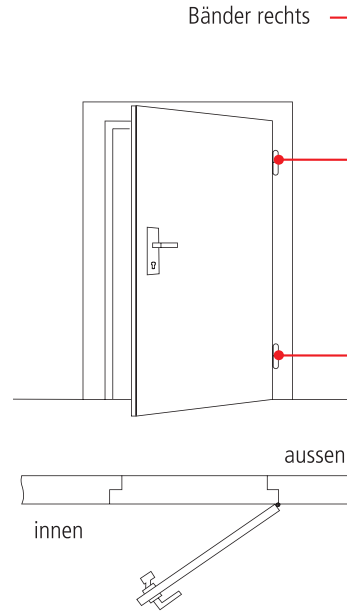
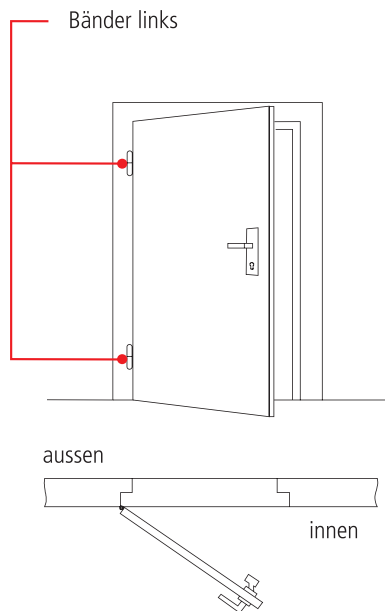

Piktogramme für Massangaben

- ⊢ Breite über alles
- ⊢^R Rosettenbreite
- ⊢ Höhe über alles
- ⊢^R Rosettenhöhe
- ⊢^G Grifflänge
- ⊢ Ausladung
- ⊢ Ausladung bis Mitte Bohrung
- ⊢ Einlasstiefe
- ⊘ Distanz Drückerloch – oberes Schraubenloch
- ⊘ Durchmesser (Bohrung, Dorn, Stange, Rohr, Seil oder Ansatz)
- ⊞ Stiftquerschnitt
- ⊘-⊘ Schraubenlochdistanz
- ≠ Überschlag
- ≠ Materialstärke
- ▨ Gewinde, Schrauben, Bolzen
- A Mass A
- ⊞ Packungsgrösse / Staffelrabatt

Standard-Lochungen

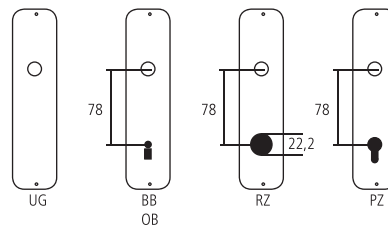

Standard-Türstärken

- Zimmertüren: 40 mm
- Haustüren: 60 mm

Nr.	Artikel/Ausführung	CHF	Nr.	Artikel/Ausführung	CHF	Nr.	Artikel/Ausführung	CHF
Drückerlochteile			Schilder			Schilder		
1655	Ansatz auf 15 mm überdreht	15.00	1571	Drückerführung 16 mm ausgebohrt	9.00	1532	Sonderlochung 32 mm	18.00
1656	Ansatz auf 16 mm überdreht	15.00	1570	Drückerführung 18 mm ausgebohrt	9.00	1533	Sonderlochung 33 mm	28.00
1653	Ansatz auf 18 mm überdreht	15.00	1573	Drückerloch versetzt	25.00	1536	Sonderlochung 36 mm	28.00
1669	drehbar vernietet	19.00	1581	Fremdfabrikat CRNI stanzen	9.00	1504	Sonderlochung 4 mm	4.50
1605	Inbus bohren M6	5.50	1580	Fremdfabrikat stanzen	8.00	1506	Sonderlochung 6 mm	4.50
1600	Lochteil 6 mm speziell	3.00	1574	gebohrt für SI-Rosetten oval	20.00	1508	Sonderlochung 8 mm	4.50
1601	Lochteil 7 mm speziell	3.00	1576	gebohrt für SI-Rosetten rund	20.00	1502	Sonderlochung BB Esp.	4.50
1602	Lochteil 8 mm speziell	3.00	1575	gebohrt für Stabilschrauben	9.00	1503	Sonderlochung BB gross (24 mm)	4.50
1657	mit Gewinde M12 / Tiefe 20	12.00	3150	gelocht BB 50	4.50	1501	Sonderlochung BB Möbel	4.50
1658	mit Gewinde M12x1.25 / Tiefe 20	12.00	3155	gelocht BB 55	4.50	3048	Sonderlochung Distanz 48 mm	4.50
1654	ohne Ansatz	12.00	3160	gelocht BB 60	4.50		bis	
Drückerpaare			3161	gelocht BB 61	4.50	3099	Sonderlochung Distanz 99 mm	4.50
6100	Holzdicke 100 mm	4.00	3170	gelocht BB 70	4.50	1568	Sonderlochung KEK	10.00
6110	Holzdicke 110 mm	4.00	3172	gelocht BB 72	4.50	Schlüssel		
6120	Holzdicke 120 mm	4.00	3178	gelocht BB 78		2100	Reide aufgepresst	19.00
6130	Holzdicke 130 mm	4.00	3185	gelocht BB 85	4.50	2101	Reide aufgepresst + verlängert	39.00
6030	Holzdicke 30 mm	4.00	3188	gelocht BB 88	4.50	2130	Reide fest auf Schild	20.00
6040	Holzdicke 40 mm		3190	gelocht BB 90	4.50	2128	Reide mit Gewinde M 5	10.00
6050	Holzdicke 50 mm		3192	gelocht BB 92	4.50	2129	Reide mit Gewinde M 6	10.00
6060	Holzdicke 60 mm		3307	gelocht PZ 107.5	4.50	2104	Schlüssel verkürzt	25.00
6070	Holzdicke 70 mm	4.00	3308	gelocht PZ 108	4.50	2105	Schlüssel verlängert	25.00
6080	Holzdicke 80 mm	4.00	3324	gelocht PZ 124	4.50	Schrankoliven		
6090	Holzdicke 90 mm	4.00	3348	gelocht PZ 48.3	4.50	1782	Möbelknopf mit Stift 7x32	9.00
1610	Stiftquerschnitt 10 mm speziell	12.00	3353	gelocht PZ 53	4.50	1783	Möbelknopf mit Stift 7x37	9.00
1606	Stiftquerschnitt 6 mm speziell	5.50	3355	gelocht PZ 55	4.50	1784	Möbelknopf mit Stift 7x42	9.00
1607	Stiftquerschnitt 7 mm speziell	5.50	3356	gelocht PZ 56	4.50	1785	Möbelknopf mit Stift 7x52	9.00
1608	Stiftquerschnitt 8 mm speziell	5.50	3360	gelocht PZ 60	4.50	1786	Möbelknopf mit Stift 7x62	9.00
1609	Stiftquerschnitt 9 mm speziell	5.50	3370	gelocht PZ 70	4.50	Türkнопfe		
Fenstergriffe			3372	gelocht PZ 72	4.50	1792	Esp.-Knopf mit Stift 7x32	20.00
1735	Ausführung FRI / 45°-Rastung	20.00	3378	gelocht PZ 78		1793	Esp.-Knopf mit Stift 7x37	20.00
1732	Nocken auf 10 mm abgefräst	18.00	3388	gelocht PZ 88	4.50	1794	Esp.-Knopf mit Stift 7x42	20.00
1740	STG Steckgriff	12.00	3390	gelocht PZ 90	4.50	1795	Esp.-Knopf mit Stift 7x52	20.00
7230	Stift 7 mm: 30 mm vorstehend	4.00	3392	gelocht PZ 92	4.50	1796	Esp.-Knopf mit Stift 7x62	20.00
7232	Stift 7 mm: 32 mm vorstehend	4.00	3207	gelocht RZ 107.5	4.50	1671	fest ohne Stift: M 12	35.00
7235	Stift 7 mm: 35 mm vorstehend		3208	gelocht RZ 108	4.50	1672	fest ohne Stift: M 12x1.25	35.00
7240	Stift 7 mm: 40 mm vorstehend	4.00	3208	gelocht RZ 108	4.50	1673	fest ohne Gewinde	19.00
7245	Stift 7 mm: 45 mm vorstehend	4.00	3226	gelocht RZ 126	4.50	1670	fest vernietet (mit Mutter)	19.00
Hebeschiebetürgriffe			3250	gelocht RZ 50.3	4.50	1659	für Zugkastenschloss	22.00
1776	HS Ausf. HSK mit Kipp Sperre	85.00	3255	gelocht RZ 55	4.50	1687	Knopf montieren	9.00
1773	HS gelocht PZ 69 mm	4.50	3258	gelocht RZ 58	4.50	1692	Garagetorknopf Stift 9x60	15.00
1772	HS gelocht RZ 70.3 mm	4.50	3260	gelocht RZ 60	4.50	1693	Garagetorknopf Stift 9x90	15.00
1777	HS Griff zu Sigenia PSK	50.00	3261	gelocht RZ 61	4.50	Zierhülsen für Bänder		
1778	HS mit Stift 12 mm	20.00	3272	gelocht RZ 72	4.50	1954	einseitig abgedreht	7.50
1774	HS Stift 8 mm	8.00	3274	gelocht RZ 74	4.50	1957	Endhülse gefräst zu HES Band	15.00
1775	HS Vierkantloch 8 mm	8.00	3278	gelocht RZ 78		1956	Endhülse gefräst zu HS Band	15.00
Sonnerieplatten			3290	gelocht RZ 90	4.50	1955	Mittelhülse beids. abgedreht	15.00
1960	gelocht SKR	52.00	3292	gelocht RZ 92	4.50	1959	Mittelhülse gefräst zu HESBand	7.50
Oliven			3294	gelocht RZ 94	4.50	1958	Mittelhülse gefräst zu HS Band	7.50
1690	Garagetorolive Stift 9x60	15.00	3296	gelocht RZ 96	4.50	Zylinderoliven		
1691	Garagetorolive Stift 9x90	15.00	1510	Sonderlochung 10 mm	4.50	1762	angel. Zylinder montieren MS	15.00
Rohre			1511	Sonderlochung 11 mm	4.50	1761	angel. Zylinder montieren SE	15.00
2200	Fixlänge (1-4 St)	12.00	1512	Sonderlochung 12 mm	4.50	1763	GS nach Musterschlüssel	20.00
2201	Fixlänge (5-9 St)	9.00	1513	Sonderlochung 13 mm	4.50	1766	linke Ausführung MS-Zyl.-Olive	8.00
2202	Fixlänge (10+St)	6.00	1514	Sonderlochung 14 mm	4.50	1765	linke Ausführung SE-Zyl.-Olive	8.00
			1515	Sonderlochung 15 mm	4.50			
			1516	Sonderlochung 16 mm	4.50			
			1518	Sonderlochung 18 mm	4.50			
			1520	Sonderlochung 20 mm	4.50			
			1521	Sonderlochung 21 mm	4.50			
			1526	Sonderlochung 26 mm	18.00			
			1530	Sonderlochung 30 mm	18.00			

Spezielle Oberflächen

Wünschen Sie einen Artikel aus diesem Katalog in einer anderen Oberfläche? Gerne färben wir jeden Artikel in eine der unten aufgeführten Oberfläche um. Die entsprechenden Preise entnehmen Sie bitte der Tabelle. Rechnen Sie mit einer Lieferfrist von rund 4 Wochen!

Individuelle Anfertigungen

Haben Sie in diesem Katalog ein Produkt gesucht, aber nicht gefunden? Oder benötigen Sie für einen anspruchsvollen Kunden ein individuelles Produkt? Kein Problem! Für unsere versierten Schmiede ist fast nichts unmöglich. Schicken Sie uns Ihre Skizzen oder teilen Sie uns Ihre Vorstellungen mit. Wir klären für Sie Machbarkeit und Preise ab und erstellen Ihnen gerne eine entsprechende Offerte.

Register	Bezeichnung	Einheit	10. verzinkt und patiniert	12. thermopatiniert	15. verzinkt-althpatiniert	16. gerostet
			CHF	CHF	CHF	CHF
1	Drückerlochteile	Stk.	15.00	25.00	30.00	
1	Rosetten	Stk.	10.00	12.50	15.00	
1	Schilder	Stk.	15.00	25.00	30.00	
2	Muschelgriffe	Stk.	15.00	20.00	25.00	
2	Türknohf-Lochteile	Stk.	15.00	25.00	30.00	
2	WC-Oliven	Pr	10.00	15.00	20.00	
3	Fenstergriffe	Stk.	25.00	35.00	45.00	
3	Fensteroliven	Stk.	20.00	30.00	40.00	
3	Hebeschiebetürgriffe	Stk.	40.00	70.00	90.00	
4	Bolzenstützkloben	Stk.	10.00	15.00	20.00	
4	Plattenkloben	Stk.	15.00	25.00	30.00	
4	Winkelbänder/Mittelbänder	Stk.	15.00	25.00	30.00	
5	Einbohrbänder	Stk.	10.00	12.50	15.00	
5	Fiszbänder < 130mm	Stk.	10.00	12.50	15.00	
5	Fiszbänder > 130mm	Stk.	10.00	15.00	20.00	
5	Kloben	Stk.	15.00	25.00	30.00	
5	Türbänder > 301mm	Stk.	20.00	30.00	40.00	
5	Türbänder < 301mm	Stk.	30.00	40.00	50.00	
5	Zierhülsen	Stk.	10.00	12.50	15.00	
6	Riegel < 190mm	Stk.	20.00	30.00	40.00	
6	Riegel > 190mm	Stk.	30.00	40.00	50.00	
6	Türklopfer	Stk.	40.00	70.00	90.00	
7	Haken	Stk.	10.00	12.50	15.00	
7	Haken mit Grundplatte	Stk.	15.00	20.00	25.00	
7	Vorhangstangen/Garderobestangen	m	50.00	70.00	95.00	
7	Wandlager	Stk.	10.00	15.00	20.00	
8	Möbelgriffe	Stk.	10.00	15.00	20.00	
8	Möbelknöpfe < 41mm	Stk.	10.00	12.50	15.00	
8	Möbelknöpfe > 41mm	Stk.	10.00	15.00	20.00	
8	Möbelschilder	Stk.	10.00	12.50	15.00	
8	Schlüsselreiden	Stk.	10.00	12.50	15.00	

HAGER
DUROQUICK®

Alle Türgehäusen mit dem Logo «Hager DURO-QUICK®» sind mit diesem revolutionären Befestigungssystem ausgerüstet. Mit wenigen Bauteilen ist damit eine individuelle Anpassung an die örtlichen Gegebenheiten direkt auf der Baustelle möglich.

Schraube lose Schraube fest

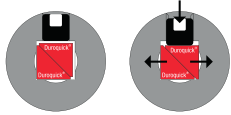

Der DUROQUICK®-Stift besteht aus zwei Dreikantprofilen, die sich beim Festziehen der Schrauben im Vierkantloch des Drückers und in der Schlossnuss verkeilen.

Montage Die Inbusschrauben müssen vor der Montage lose sein. Einen Drücker mit Stift in die Schlossnuss einstecken und den zweiten Drücker auf der Gegenseite aufstecken, gegeneinander drücken und Inbusschrauben fest anziehen.

Vorteile Wackelfreie, kraftschlüssige Verbindung im Drücker und im Schloss, schnelle Montage und Demontage, einfaches Anpassen der Türstärke durch Wechseln der Stiftlänge, vereinfachte Lagerhaltung und Logistik, 100 % recycelfähig dank einfacher Materialtrennung

Garnituren Die Drückerpaare werden mit loseem Stift und zwei Inbusschrauben geliefert. Sämtliche Türknöpfe können sowohl paarweise als auch für Wechselgarnituren verwendet werden.

Drückergarnituren



Verbindungsstift
Hager DUROQUICK®
Artikel-Nr. 60.1916.2



Verbindungsstift
Hager DUROQUICK®
Artikel-Nr. 60.1916.2

Wechselgarnituren



Wechselstift
Hager DUROQUICK®
Artikel-Nr. 60.1916.5
zum Fixieren von
Türknöpfen auf Lang-
schildern



Wechselstift
Hager DUROQUICK®
Artikel-Nr. 60.1916.5
zum Fixieren von Tür-
knöpfen auf Rosetten

WC-Türgarnituren



WC-Riegel mit
Notöffner passend
auf Langschilder mit
RZ-Lochung



WC-Riegel mit
Notöffner passend auf
Drückerrosetten



Alle Fenstergriffe mit dem Logo «Hager MULTITAC®» sind mit diesem modularen Rastersystem ausgerüstet. Damit können Fenstergriffe und Oliven beliebig mit Rosetten kombiniert werden. Das System erlaubt die Montage von Fenstergriffen passend zu allen bekannten Fabrikaten und Anwendungen.



Das Rastersystem HAGER MULTITAC® vereint Flexibilität und Qualität dank Metallführung und gehärteten Verschleissteilen.

Rot: gehärtete Rasterung, Dunkelgrau: Fenstergriffan-satz, Hellgrau: Rosettenführung mit Feder

Montage Die Fenstergriffe werden in unserer Spezialwerkstatt kommissionweise montiert. Alle Einzelteile sind ab unserem Lager verfügbar. Damit sind maximale Flexibilität und rasche Verfügbarkeit garantiert.

Vorteile solide, langlebige Mechanik, individuelle Kombinationsmöglichkeiten, passend zu allen gängigen Fabrikaten, grosse Palette an Ausführungsvarianten, Möglichkeit von Sonderanfertigungen (auch Fremdfabrikate)

Ausführungsvarianten Fenstergriffe und -Oliven, Fenstertürgriffe für Innen und Aussen, Zylinderrosetten und Verschlussriegel für Fenstertüren, 45°-Rastung für integrierte Spaltlüftung, Steckgriffe und Steckrosetten, abschliessbare Rosetten, Griffe für Parallelschiebe- und Schiebekippfenster und -Türen.

Beschlagvariante A für Fenstertüren

nur von Innen verriegelbar

Bei dieser einfachen Variante ist keine Verbreiterung des Flügelrahmens notwendig. Ein normales Fenstergetriebe mit kleinem Dornmass kommt zum Einsatz. Als Innengriff genügt ein normaler Fenstergriff. Aussen wird die Fenstertüre mit einem Muschelgriff bedient wobei ein Schöpfer den Flügel in der geschlossenen Stellung einrasten lässt. Der Einbruchschutz ist minimal.



- ① Fenstergriff Hager MULTITAC® Ausführung FR
- ② Muschelgriff
- ③ Fenstergetriebe
- ④ Schnapper

Beschlagvariante B für Fenstertüren mit Verschlussriegel

nur von Innen verriegelbar

Mit durchgehender Griffgarnitur für beidseitige Bedienung. Getriebe mit Schloss und mit erhöhtem Dornmass. Verbreiterung des Flügelrahmens notwendig. Mit dem Verschlussriegel wird der Beschlag gegen Verschieben von Innen verriegelt.

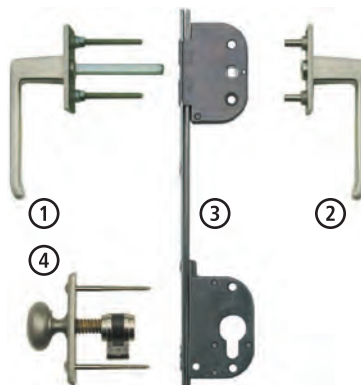

- ① Innengriff Hager MULTITAC® Ausführung IR
- ② Aussengriff Hager MULTITAC® Ausführung AR
- ③ Fenstertürgetriebe mit Schloss
- ④ Verriegelungsknopf Hager MULTITAC® Ausführung VR

Beschlagvariante C für Fenstertüren mit Doppelzylinder

auch von aussen verriegelbar

Mit durchgehender Griffgarnitur für beidseitige Bedienung. Getriebe mit Schloss und mit erhöhtem Dornmass. Verbreiterung des Flügelrahmens notwendig. Mit dem Schliesszylinder wird der Beschlag gegen Verschieben von Innen verriegelt. Bei Verwendung eines Doppelzylinders ist die Verriegelung von Aussen möglich.

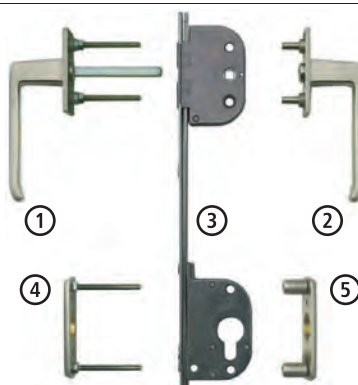

- ① Innengriff Hager MULTITAC® Ausführung IR
- ② Aussengriff Hager MULTITAC® Ausführung AR
- ③ Fenstertürgetriebe mit Schloss
- ④ Zylinderrosette innen Ausführung I
- ⑤ Zylinderrosette aussen Ausführung A

WISSENSWERTES über Herstellungsverfahren und Oberflächen

Handgeschmiedete Beschläge

Schmieden ist eine der ältesten Arbeitstechniken des Menschen. Wie vor Zeiten arbeiten unsere Schmiede noch mit Hammer, Amboss und Kohlen-Esse. Dabei wird das Eisen in der Esse erwärmt bis es glüht und danach mit dem Hammer in die gewünschte Form geschmiedet. Jedes Stück ist somit ein Unikat. Geringe Massabweichungen sind verfahrensbedingt. Unsere handgeschmiedeten Beschläge stammen zu 95% aus Schweizer Produktion.



Eisen naturblank

Durch das Schmieden entsteht auf dem Artikel eine verzünderte, gehämmerte Struktur. Die Artikel werden nach dem Schmiedeprozess von Hand durchgebürstet. Anschliessend werden die Beschläge in ein Mattlackbad getaucht. Dieser Mattlack schützt die Beschläge soweit, dass sie unter normalen Raumbedingungen im Innenbereich nicht zu rosten beginnen. Für eine Aussenanwendung ist dieser Oberflächenschutz aber nicht geeignet, ebenso in Schwimmbädern und anderen Feuchträumen. In Neubauten dürfen die Beschläge ausserdem erst montiert werden, wenn die Bauaustrocknung weit fortgeschritten ist.

Eisen verzinkt-altpatiniert

Die Artikel werden nach dem Schmieden zuerst sandgestrahlt, gebeizt und entfettet. Anschliessend werden die Teile galvanisch verzinkt und phosphatiert. Danach erhält die Oberfläche eine Schwarzlackierung. Nun erfolgt in Handarbeit das Durchreiben mit Stahlwolle, um eine edle Patina zu erreichen. Zu guter Letzt werden die Beschläge mit einem Mattlack lackiert, was die Resistenz gegen Abgreifen und Witterungseinflüsse zusätzlich erhöht. Diese Oberfläche ist für die Aussenanwendung geeignet.

Eisen gerostet

Die Artikel werden nach dem Schmieden zuerst sandgestrahlt und entfettet. Anschliessend werden die Teile gerostet. Dieser Prozess dauert rund 5 Tage. Nach dem Rosten werden die Artikel mit einem speziellen Wachs eingewachst. Dieses Wachs bietet einen gewissen Schutz und verhindert vor allem das Weiterrosten. Für eine Aussenanwendung ist diese Oberfläche aber nicht geeignet, ebenso in Schwimmbädern und anderen Feuchträumen. In Neubauten dürfen die Beschläge ausserdem erst montiert werden, wenn die Bauaustrocknung weit fortgeschritten ist.

Bronze-Beschläge

Unsere Bronzebeschläge werden im Sandgussverfahren von einer kleinen, italienischen Manufaktur hergestellt. Dabei wird ein Gussmodell in Sand abgeformt, das Modell entfernt und der verbliebene Hohlraum mit der geschmolzenen Bronze ausgegossen. Die Bronze fliesst dank ihres Eigengewichtes durch die Zuleitungen in die Sandform. Bereits wenige Minuten nach dem Giessen können die noch glühenden Gussteile aus der Sandform herausgelöst werden. Sobald die Teile abgekühlt sind, werden die Angussstücke abgetrennt und der Artikel zur Oberflächenbehandlung vorbereitet. Jedes Stück ist ein Unikat.



Bronze dunkel

Durch das Sandgussverfahren entsteht bewusst eine leicht poröse und dadurch rustikal wirkende Oberflächenstruktur. Die Teile werden dann mit einer speziellen Brünierflüssigkeit behandelt und anschliessend durchgerieben und satiniert. Diese Oberfläche ist für die Innen- und Aussenanwendung geeignet. Für die Reinigung empfehlen wir ein weiches, trockenes Tuch.

Bronze versilbert

Wie bei Bronze dunkel entsteht durch das Sandgussverfahren eine leicht poröse und dadurch rustikal wirkende Oberflächenstruktur. Die Teile werden anschliessend in ein Silberbad getaucht, wodurch diese exklusive Oberfläche entsteht. Diese Oberfläche ist für die Innen- und Aussenanwendung geeignet. Für die Reinigung empfehlen wir Silberputzmittel.

HAGER FÜR SIE: Mit Fachwissen, Zuverlässigkeit und Leidenschaft.



VON DER KOMPETENTEN
BERATUNG ÜBER DIE EXAKTE
PLANUNG BIS HIN ZUR INDI-
VIDUELLEN PROBLEMLÖSUNG:
BEI HAGER GIBTS ALLES AUS
EINER HAND.

Geschichte

Am 1. Juni 1964 gründeten Alfred und Curt Hager die Einzelfirma Curt Hager Beschläge en gros. Am Anfang führten die Unternehmer neben vier Messing- und sieben Schmiedeeisengarnituren sogar Kuhschwanzhalter und Maschinen im Sortiment. Nach und nach spezialisierte sich die Firma auf Zierbeschläge. Im Jahr 1983 wurde die kontinuierlich gewachsene Einzelfirma in eine Aktiengesellschaft umgewandelt. Am 1. Juni 2004, 40 Jahre nach der Gründung, übernahm mit Adrian Hager bereits die dritte Generation die Geschäftsleitung. Mit 26 motivierten Mitarbeitern zählt die Hager Zierbeschläge AG heute zu einem der führenden Grossisten für Zierbeschläge auf dem Schweizer Markt.

Leitspruch

Die selbst auferlegte Verpflichtung «Auf uns ist Verlass» ist eine immerwährende Herausforderung, unsere Kunden in jeder Beziehung überdurchschnittlich zu bedienen – denn Zierbeschläge sind unsere Leidenschaft! Darum bringen uns auch ausgefallene Wünsche nicht so schnell in Verlegenheit.

Sortiment

Unser aktuelles Sortiment umfasst rund 10 000 Artikel aus den Bereichen Tür-, Fenster-, und Möbelbeschläge. Ob antike Griffchen für Grossmutter's Kommode, rustikale Beschläge für das Chalet in den Bergen oder moderne, kubische Formen für die Villa am See: in unserem Sortiment finden Sie für fast jeden Anwendungsbereich und Geschmack eine ausgewogene Auswahl. Die langjährigen Geschäftsbeziehungen mit unseren Lieferanten garantieren eine einwandfreie Qualität.



FÜR JEDEN STIL UND GE-
SCHMACK DAS PASSENDE AN-
LAGER: BEI HAGER IST AUS-
WAHL, EFFIZIENZ UND
TERMIN-TREUE ALLES EINE
FRAGE DES KNOW-HOWS.

Anerkennung der Verkaufs- und Lieferbedingungen

Durch die Bestellungerteilung anerkennt der Käufer, ohne gegenteilige schriftliche Abmachung, sämtliche Punkte dieser Verkaufs- und Lieferbedingungen.

Abbildungen und Angaben

Die angegebenen Abmessungen sind Richtmasse. Geringfügige Abweichungen sind bedingt durch den Herstellungsprozess möglich. Alle Abbildungen und Angaben sind unverbindlich. Modelländerungen bleiben vorbehalten. Asymmetrische Artikel sind jeweils in der rechten Ausführung abgebildet.

Preise

Die in diesem Katalog genannten Preise sind Verkaufsrichtpreise exkl. Mehrwertsteuer in CHF für Standardausführungen nach Schweizer Norm, Stand bei Drucklegung. Für abweichende Ausführungen werden entsprechende Aufpreise angerechnet. Verpackung, Transport und Montage sind nicht inbegriffen. Preisänderungen ohne Vorankündigung bleiben vorbehalten.

Porto und Verpackung

Sendungen mit einem Nettowarenwert über CHF 750.– liefern wir in der Regel franko und ohne Verrechnung von Verpackung. Für alle Sendungen unter einem Lieferwert von CHF 750.– sowie für alle Express- und Sperrgutsendungen (ab 1m) werden die Versand- und Verpackungskosten in Rechnung gestellt.

Lieferfristen

Alle Beschläge sind grundsätzlich ab unserem Lager in Niederurnen äusserst kurzfristig lieferbar. Schadenersatzforderungen wegen verspäteter Lieferung können nicht anerkannt werden.

Beanstandungen

Die Kontrolle unserer Lieferungen hat sofort nach Erhalt zu erfolgen. Beanstandungen sind spätestens innert 8 Tagen anzubringen, ansonsten die Sendung als korrekt geliefert gilt. Bei Beschädigung oder Verlust ist der Empfänger verpflichtet, beim Spediteur vor Annahme der Sendung einen Befund aufnehmen zu lassen.

Garantie (Gewährleistungsausschluss)

Sämtliche in diesem Katalog abgebildeten Beschläge sind aus massivem Material hergestellt und von bester Qualität und Verarbeitung. Für Waren mit festgestellten Material- und Konstruktionsfehlern leisten wir während 6 Monaten nach Lieferung Ersatz bzw. Instandstellung in unserem Haus. Weitere Schadenersatzansprüche lehnen wir ab.

Rücksendungen

Bei Rücksendungen ist eine Kopie der Rechnung oder des Lieferscheins beizulegen. Ansonsten schreiben wir nur 75 % des effektiven Warenwertes gut. Spezialanfertigungen und Waren, die wir nicht im Lagersortiment führen, können nicht zurück genommen werden. Nicht korrekt verpackte und beschädigte Artikel werden nicht gutgeschrieben.

Wir behalten uns vor, für Umtriebe und Instandstellung den Betrag der Gut-schrift entsprechend zu kürzen.

Eigentums- und Urheberrecht

Jede Verwertung bildlicher oder textlicher Darstellungen aus diesem Katalog ist ohne unsere schriftliche Genehmigung verboten.

Eisen naturblank
 Eisen verzinkt-allpatiniert
 Eisen gerostet
 Bronze dunkel
 Bronze versilbert

Rosettengarnituren

Seite 1.02
 Seite 1.14
 Seite 1.21
 Seite 1.26
 Seite 1.30



Eisen naturblank

Seite 1.05

Kurzschildgarnituren



Eisen naturblank
 Eisen verzinkt-allpatiniert
 Eisen gerostet
 Bronze dunkel
 Bronze versilbert

Seite 1.06
 Seite 1.16
 Seite 1.23
 Seite 1.28
 Seite 1.32

Langschildgarnituren

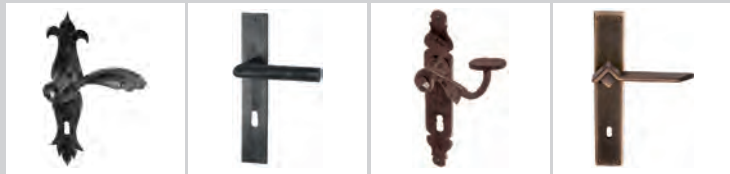

**Türgarnitur Serie Zupò**Eisen naturblank
mit Hochstelfeder

Bezeichnung	Bestellnummer	H	I	H	Ø	□	⊙	CHF
Zimmertürgarnitur								
Zimmertürdrücker	13.142.0	120	60	18	8			Pr 188.00
Drücker-Lochteil	13.142.2	120	60	18	8			St 94.00
Drückerrosette	13.197/18-8mm	54	54	11.5	18	8	38	St 39.00
Schlüsselrosette blind	13.197 UG	54	54	11.5			38	St 39.00
Schlüsselrosette	13.197 BB	54	54	11.5			38	St 39.00
Zylinderrosette	13.197 RZ	54	54	11.5			38	St 39.00
Zylinderrosette	13.197 PZ	54	54	11.5			38	St 39.00
Haustürgarnitur								
Haustürdrücker	13.142H.0	135	60	18	9			Pr 250.00
Drücker-Lochteil	13.142H.2	135	60	18	9			St 125.00
Drückerrosette	13.197/18-9mm	54	54	11.5	18	9	38	St 44.50

Türgarnitur Serie Zupò

Eisen naturblank



Bezeichnung	Bestellnummer	H	I	H	Ø	□	⊙	CHF
Zimmertürgarnitur								
Zimmertürdrücker	13.142.0	120	60	18	8			Pr 188.00
Drücker-Lochteil	13.142.2	120	60	18	8			St 94.00
Drückerrosette	13.205	52	52	3	18		38	St 40.50
Schlüsselrosette blind	13.205 UG	52	52	3			38	St 40.50
Schlüsselrosette	13.205 BB	52	52	3			38	St 40.50
Zylinderrosette	13.205 RZ	52	52	3			38	St 40.50
Zylinderrosette	13.205 PZ	52	52	3			38	St 40.50
Haustürgarnitur								
Haustürdrücker	13.142H.0	135	60	18	9			Pr 250.00
Drücker-Lochteil	13.142H.2	135	60	18	9			St 125.00
Drückerrosette	13.205H	58	58	3	18		38	St 49.00
Schlüsselrosette blind	13.205H UG	58	58	3			38	St 49.00
Zylinderrosette	13.205H RZ	58	58	3			38	St 49.00
Zylinderrosette	13.205H PZ	58	58	3			38	St 49.00

Haustürgarnitur Serie ZupòEisen naturblank
mit Hochstelfeder / Türgriff erfüllt massliche Anforderungen nach DIN EN 179

Bezeichnung	Bestellnummer	H	I	H	H	Ø	□	CHF
Haustürgarnitur								
Haustürdrücker	13.142HFW.0/16	145	22	60		16	9	Pr 290.00
Drücker-Lochteil	13.142HFW.2/16	145	22	60		16	9	St 145.00
Drückerrosetten	13.205H/16 RF Pr	58	58	3	10	16		Pr 126.80
Zylinderrosetten	13.205H RZ Pr	58	58	3				Pr 105.80
Zylinderrosetten	13.205H PZ Pr	58	58	3				Pr 105.80

Türgarnitur Serie Bernina

Eisen naturblank
mit Hochstellfeder



Bezeichnung	Bestellnummer	H	I	H	Ø	∇	∞	CHF
Zimmertürgarnitur								
Zimmertürdrücker	13.143.0	120	60	18	8			Pr 187.00
Drücker-Lochteil	13.143.2	120	60	18	8			St 93.50
Drückerrosette	13.197/18-8mm	54	54	11.5	18	8	38	St 39.00
Schlüsselrosette blind	13.197 UG	54	54	11.5			38	St 39.00
Schlüsselrosette	13.197 BB	54	54	11.5			38	St 39.00
Zylinderrosette	13.197 RZ	54	54	11.5			38	St 39.00
Zylinderrosette	13.197 PZ	54	54	11.5			38	St 39.00



Türgarnitur Serie Alv

Eisen naturblank
mit Hochstellfeder



Bezeichnung	Bestellnummer	H	I	H	Ø	∇	∞	CHF
Zimmertürgarnitur								
Zimmertürdrücker	13.144.0	120	50	18	8			Pr 186.00
Drücker-Lochteil	13.144.2	120	50	18	8			St 93.00
Drückerrosette	13.200/18-8mm	53	53	11.5	18	8	38	St 39.00
Schlüsselrosette blind	13.200 UG	53	53	11.5			38	St 39.00
Schlüsselrosette	13.200 BB	53	53	11.5			38	St 39.00
Zylinderrosette	13.200 RZ	53	53	11.5			38	St 39.00
Zylinderrosette	13.200 PZ	53	53	11.5			38	St 39.00



Türgarnitur Serie Zinal

Eisen naturblank
mit Hochstellfeder



Bezeichnung	Bestellnummer	H	I	H	Ø	∇	∞	CHF
Zimmertürgarnitur								
Zimmertürdrücker	13.145.0	120	53	18	8			Pr 178.00
Drücker-Lochteil	13.145.2	120	53	18	8			St 89.00
Drückerrosette	13.200/18-8mm	53	53	11.5	18	8	38	St 39.00
Schlüsselrosette blind	13.200 UG	53	53	11.5			38	St 39.00
Schlüsselrosette	13.200 BB	53	53	11.5			38	St 39.00
Zylinderrosette	13.200 RZ	53	53	11.5			38	St 39.00
Zylinderrosette	13.200 PZ	53	53	11.5			38	St 39.00





Türgarnitur Serie Spedia

Eisen naturblank

Bezeichnung	Bestellnummer	H	I	H	Ø	∇	⊙	CHF
Zimmertürgarnitur								
Zimmertürdrücker	13.146.0	122	55	18	8		Pr	184.00
Drücker-Lochteil	13.146.2	122	55	18	8		St	92.00
Drückerrosette	13.205	52	52	3	18		38	St 40.50
Schlüsselrosette blind	13.205 UG	52	52	3			38	St 40.50
Schlüsselrosette	13.205 BB	52	52	3			38	St 40.50
Zylinderrosette	13.205 RZ	52	52	3			38	St 40.50
Zylinderrosette	13.205 PZ	52	52	3			38	St 40.50
Haustürgarnitur								
Haustürdrücker	13.146H.0	135	55	18	9		Pr	242.00
Drücker-Lochteil	13.146H.2	135	55	18	9		St	121.00
Drückerrosette	13.205H	58	58	3	18		38	St 49.00
Schlüsselrosette blind	13.205H UG	58	58	3			38	St 49.00
Zylinderrosette	13.205H RZ	58	58	3			38	St 49.00
Zylinderrosette	13.205H PZ	58	58	3			38	St 49.00

Haustürgarnitur Serie Spedia

Eisen naturblank

mit Hochstelfeder / Türgriff erfüllt massliche Anforderungen nach DIN EN 179

Bezeichnung	Bestellnummer	H	I	H	H	Ø	∇	CHF
Haustürgarnitur								
Haustürdrücker	13.146HFW.0/16	145	22	60		16	9	Pr 290.00
Drücker-Lochteil	13.146HFW.2/16	145	22	60		16	9	St 145.00
Drückerrosetten	13.205H/16 RF Pr	58	58	3	10	16		Pr 126.80
Zylinderrosetten	13.205H RZ Pr	58	58	3				Pr 105.80
Zylinderrosetten	13.205H PZ Pr	58	58	3				Pr 105.80

Türgarnitur Serie Besso

Eisen naturblank

Bezeichnung	Bestellnummer	H	I	H	Ø	∇	⊙	CHF
Zimmertürgarnitur								
Zimmertürdrücker	13.148.0	120	59	18	8		Pr	168.00
Drücker-Lochteil	13.148.2	120	59	18	8		St	84.00
Drückerrosette	13.205	52	52	3	18		38	St 40.50
Schlüsselrosette blind	13.205 UG	52	52	3			38	St 40.50
Schlüsselrosette	13.205 BB	52	52	3			38	St 40.50
Zylinderrosette	13.205 RZ	52	52	3			38	St 40.50
Zylinderrosette	13.205 PZ	52	52	3			38	St 40.50

Türgarnitur Serie Parrot

Eisen naturblank

mit Hochstelfeder

Bezeichnung	Bestellnummer	H	I	H	Ø	∇	⊙	CHF
Zimmertürgarnitur								
Zimmertürdrücker	13.185.0	115	50	18	8		Pr	160.00
Drücker-Lochteil	13.185.2	115	50	18	8		St	80.00
Drückerrosette	13.197/18-8mm	54	54	11.5	18	8	38	St 39.00
Schlüsselrosette blind	13.197 UG	54	54	11.5			38	St 39.00
Schlüsselrosette	13.197 BB	54	54	11.5			38	St 39.00
Zylinderrosette	13.197 RZ	54	54	11.5			38	St 39.00
Zylinderrosette	13.197 PZ	54	54	11.5			38	St 39.00

Türgarnitur Serie Pollux

Eisen naturblank



Bezeichnung	Bestellnummer	H	H	Ø	□	∞	CHF
Zimmertürgarnitur							
Zimmertürdrücker	13.186.0	120	52	18	8		Pr 179.00
Drücker-Lochteil	13.186.2	120	52	18	8		St 89.50
Drückerrosette	13.198	60	3	18		38	St 40.50
Schlüsselrosette blind	13.198 UG	60	3			38	St 40.50
Schlüsselrosette	13.198 BB	60	3			38	St 40.50
Zylinderrosette	13.198 RZ	60	3			38	St 40.50
Zylinderrosette	13.198 PZ	60	3			38	St 40.50
Haustürgarnitur							
Haustürdrücker	13.186H.0	135	65	18	9		Pr 235.00
Drücker-Lochteil	13.186H.2	135	65	18	9		St 117.50



Türgarnitur Serie Combin

Eisen naturblank
mit Hochstellfeder



Bezeichnung	Bestellnummer	H	I	H	Ø	□	∞	CHF
Zimmertürgarnitur								
Zimmertürdrücker	13.188.0	130		56	18	8		Pr 160.00
Drücker-Lochteil	13.188.2	130		56	18	8		St 80.00
Drückerrosette	13.197/18-8mm	54	54	11.5	18	8	38	St 39.00
Schlüsselrosette blind	13.197 UG	54	54	11.5			38	St 39.00
Schlüsselrosette	13.197 BB	54	54	11.5			38	St 39.00
Zylinderrosette	13.197 RZ	54	54	11.5			38	St 39.00
Zylinderrosette	13.197 PZ	54	54	11.5			38	St 39.00
Haustürgarnitur								
Haustürdrücker	13.188H.0	165		67	18	9		Pr 240.00
Drücker-Lochteil	13.188H.2	165		67	18	9		St 120.00
Drückerrosette	13.197/18-9mm	54	54	11.5	18	9	38	St 44.50



Türgarnitur Serie Spedia

Eisen naturblank



Bezeichnung	Bestellnummer	H	I	H	∅	Ø	□	CHF
Zimmertürgarnitur								
Zimmertürdrücker	13.146.0	122		55	18	8		Pr 184.00
Drücker-Lochteil	13.146.2	122		55	18	8		St 92.00
Zimmertürschild	13.147K UG	40	160	2	40	18		St 57.50
Zimmertürschild	13.147K BB55	40	160	2	40	18		St 62.00
Zimmertürschild	13.147K RZ55	40	160	2	40	18		St 62.00



Türgarnitur Serie Pollux

Eisen naturblank



Bezeichnung	Bestellnummer	H	I	H	Ø	□	CHF
Zimmertürgarnitur							
Zimmertürdrücker	13.186.0	120		52	18	8	Pr 179.00
Drücker-Lochteil	13.186.2	120		52	18	8	St 89.50
Zimmertürschild	13.140K UG	50	150	2	18		St 64.50
Zimmertürschild	13.140K BB55	50	150	2	18		St 69.00
Zimmertürschild	13.140K RZ55	50	150	2	18		St 69.00



**Türgarnitur Serie Pollux**

Eisen naturblank



Bezeichnung	Bestellnummer	H	I	H	ø	Ø	□	CHF
Zimmertürgarnitur								
Zimmertürdrücker	13.186.0	120		52		18	8	Pr 179.00
Drücker-Lochteil	13.186.2	120		52		18	8	St 89.50
Zimmertürschild	13.187K UG	40	170	2	40	18		St 59.00
Zimmertürschild	13.187K BB55	40	170	2	40	18		St 63.50
Zimmertürschild	13.187K RZ55	40	170	2	40	18		St 63.50

**Türgarnitur Serie Combin**

Eisen naturblank



Bezeichnung	Bestellnummer	H	I	H	ø	Ø	□	CHF
Zimmertürgarnitur								
Zimmertürdrücker	13.188.0	130		56		18	8	Pr 160.00
Drücker-Lochteil	13.188.2	130		56		18	8	St 80.00
Zimmertürschild	13.191K UG	40	160	2	40	18		St 62.00
Zimmertürschild	13.191K BB55	40	160	2	40	18		St 66.50
Zimmertürschild	13.191K RZ55	40	160	2	40	18		St 66.50

**Türgarnitur Serie Bellavista**

Eisen naturblank



Bezeichnung	Bestellnummer	H	I	H	ø	Ø	□	CHF
Zimmertürgarnitur								
Zimmertürdrücker	13.100.0	135		75		18	8	Pr 210.00
Drücker-Lochteil links	13.100.2 Ls	135		75		18	8	St 105.00
Drücker-Lochteil rechts	13.100.2 Rs	135		75		18	8	St 105.00
Zimmertürschild	13.101 UG	60	245	2	70	18		St 67.50
Zimmertürschild	13.101 BB78	60	245	2	70	18		St 67.50
Zimmertürschild	13.101 RZ78	60	245	2	70	18		St 67.50
Zimmertürschild	13.101 PZ78	60	245	2	70	18		St 67.50
Haustürgarnitur								
Haustürdrücker	13.100H.0	145		75		18	9	Pr 264.00
Drücker-Lochteil links	13.100H.2 Ls	145		75		18	9	St 132.00
Drücker-Lochteil rechts	13.100H.2 Rs	145		75		18	9	St 132.00
Haustürschild	13.101H UG	85	300	3	86	18		St 105.00
Haustürschild	13.101H RZ78	85	300	3	86	18		St 105.00
Haustürschild	13.101H PZ78	85	300	3	86	18		St 105.00

Türgarnitur Serie Argient

Eisen naturblank



Bezeichnung	Bestellnummer	H	I	H	Ø	Ø	□	CHF
Zimmertürgarnitur								
Zimmertürdrücker	13.122.0	130	80		18	8		Pr 233.00
Drücker-Lochteil links	13.122.2 Ls	130	80		18	8		St 116.50
Drücker-Lochteil rechts	13.122.2 Rs	130	80		18	8		St 116.50
Zimmertürschild	13.123 UG	62	230	2	58	18		St 95.00
Zimmertürschild	13.123 BB78	62	230	2	58	18		St 95.00
Zimmertürschild	13.123 RZ78	62	230	2	58	18		St 95.00
Zimmertürschild	13.123 PZ78	62	230	2	58	18		St 95.00



Türgarnitur Serie Argient

Eisen naturblank



Bezeichnung	Bestellnummer	H	I	H	Ø	Ø	□	CHF
Zimmertürgarnitur								
Zimmertürdrücker	13.122.0	130	80		18	8		Pr 233.00
Drücker-Lochteil links	13.122.2 Ls	130	80		18	8		St 116.50
Drücker-Lochteil rechts	13.122.2 Rs	130	80		18	8		St 116.50
Zimmertürschild	13.141 UG	62	240	2	50	18		St 64.50
Zimmertürschild	13.141 BB78	62	240	2	50	18		St 64.50
Zimmertürschild	13.141 RZ78	62	240	2	50	18		St 64.50
Zimmertürschild	13.141 PZ78	62	240	2	50	18		St 64.50



Türgarnitur Serie Roseg

Eisen naturblank



Bezeichnung	Bestellnummer	H	I	H	Ø	Ø	□	CHF
Zimmertürgarnitur								
Zimmertürdrücker	13.132.0	115	60		18	8		Pr 201.00
Drücker-Lochteil links	13.132.2 Ls	115	60		18	8		St 100.50
Drücker-Lochteil rechts	13.132.2 Rs	115	60		18	8		St 100.50
Zimmertürschild	13.133 UG	40	233	2	67	18		St 68.00
Zimmertürschild	13.133 BB78	40	233	2	67	18		St 68.00
Zimmertürschild	13.133 RZ78	40	233	2	67	18		St 68.00
Zimmertürschild	13.133 PZ78	40	233	2	67	18		St 68.00



**Türgarnitur Serie Zupò**

Eisen naturblank



Bezeichnung	Bestellnummer	H	I	H	∅	∅	∏	CHF
Zimmertürgarnitur								
Zimmertürdrücker	13.142.0	120	60		18	8	Pr	188.00
Drücker-Lochteil	13.142.2	120	60		18	8	St	94.00
Zimmertürschild	13.147 UG	40	230	2	66	18	St	57.50
Zimmertürschild	13.147 BB78	40	230	2	66	18	St	57.50
Zimmertürschild	13.147 RZ78	40	230	2	66	18	St	57.50
Zimmertürschild	13.147 PZ78	40	230	2	66	18	St	57.50
Haustürgarnitur								
Haustürdrücker	13.142H.0	135	60		18	9	Pr	250.00
Drücker-Lochteil	13.142H.2	135	60		18	9	St	125.00
Haustürschild	13.147H UG	50	250	3	76	18	St	79.50
Haustürschild	13.147H RZ78	50	250	3	76	18	St	79.50
Haustürschild	13.147H PZ78	50	250	3	76	18	St	79.50

**Türgarnitur Serie Bernina**

Eisen naturblank



Bezeichnung	Bestellnummer	H	I	H	∅	∅	∏	CHF
Zimmertürgarnitur								
Zimmertürdrücker	13.143.0	120	60		18	8	Pr	187.00
Drücker-Lochteil	13.143.2	120	60		18	8	St	93.50
Zimmertürschild	13.147 UG	40	230	2	66	18	St	57.50
Zimmertürschild	13.147 BB78	40	230	2	66	18	St	57.50
Zimmertürschild	13.147 RZ78	40	230	2	66	18	St	57.50
Zimmertürschild	13.147 PZ78	40	230	2	66	18	St	57.50

**Türgarnitur Serie Alv**

Eisen naturblank



Bezeichnung	Bestellnummer	H	I	H	∅	∅	∏	CHF
Zimmertürgarnitur								
Zimmertürdrücker	13.144.0	120	50		18	8	Pr	186.00
Drücker-Lochteil	13.144.2	120	50		18	8	St	93.00
Zimmertürschild	13.147 UG	40	230	2	66	18	St	57.50
Zimmertürschild	13.147 BB78	40	230	2	66	18	St	57.50
Zimmertürschild	13.147 RZ78	40	230	2	66	18	St	57.50
Zimmertürschild	13.147 PZ78	40	230	2	66	18	St	57.50
Haustürgarnitur								
Haustürdrücker	13.144H.0	130	55		18	9	Pr	248.00
Drücker-Lochteil	13.144H.2	130	55		18	9	St	124.00
Haustürschild	13.147H UG	50	250	3	76	18	St	79.50
Haustürschild	13.147H RZ78	50	250	3	76	18	St	79.50
Haustürschild	13.147H PZ78	50	250	3	76	18	St	79.50

Türgarnitur Serie Zinal

Eisen naturblank



Bezeichnung	Bestellnummer	H	I	H	Ø	Ø	□	CHF
Zimmertürgarnitur								
Zimmertürdrücker	13.145.0	120	53		18	8		Pr 178.00
Drücker-Lochteil	13.145.2	120	53		18	8		St 89.00
Zimmertürschild	13.147 UG	40	230	2	66	18		St 57.50
Zimmertürschild	13.147 BB78	40	230	2	66	18		St 57.50
Zimmertürschild	13.147 RZ78	40	230	2	66	18		St 57.50
Zimmertürschild	13.147 PZ78	40	230	2	66	18		St 57.50



Türgarnitur Serie Spedia

Eisen naturblank



Bezeichnung	Bestellnummer	H	I	H	Ø	Ø	□	CHF
Zimmertürgarnitur								
Zimmertürdrücker	13.146.0	122	55		18	8		Pr 184.00
Drücker-Lochteil	13.146.2	122	55		18	8		St 92.00
Zimmertürschild	13.147 UG	40	230	2	66	18		St 57.50
Zimmertürschild	13.147 BB78	40	230	2	66	18		St 57.50
Zimmertürschild	13.147 RZ78	40	230	2	66	18		St 57.50
Zimmertürschild	13.147 PZ78	40	230	2	66	18		St 57.50
Haustürgarnitur								
Haustürdrücker	13.146H.0	135	55		18	9		Pr 242.00
Drücker-Lochteil	13.146H.2	135	55		18	9		St 121.00
Haustürschild	13.147H UG	50	250	3	76	18		St 79.50
Haustürschild	13.147H RZ78	50	250	3	76	18		St 79.50
Haustürschild	13.147H PZ78	50	250	3	76	18		St 79.50



Türgarnitur Serie Besso

Eisen naturblank



Bezeichnung	Bestellnummer	H	I	H	Ø	Ø	□	CHF
Zimmertürgarnitur								
Zimmertürdrücker	13.148.0	120	59		18	8		Pr 168.00
Drücker-Lochteil	13.148.2	120	59		18	8		St 84.00
Zimmertürschild	13.147 UG	40	230	2	66	18		St 57.50
Zimmertürschild	13.147 BB78	40	230	2	66	18		St 57.50
Zimmertürschild	13.147 RZ78	40	230	2	66	18		St 57.50
Zimmertürschild	13.147 PZ78	40	230	2	66	18		St 57.50



**Türgarnitur Serie Altels**

Eisen naturblank



Bezeichnung	Bestellnummer	H	I	H	ø	Ø	□	CHF
Zimmertürgarnitur								
Zimmertürdrücker	13.152.0	120	95		18	8		Pr 276.00
Drücker-Lochteil links	13.152.2 Ls	120	95		18	8		St 138.00
Drücker-Lochteil rechts	13.152.2 Rs	120	95		18	8		St 138.00
Zimmertürschild	13.105 UG	65	245	3	56	18		St 83.50
Zimmertürschild	13.105 BB78	65	245	3	56	18		St 83.50
Zimmertürschild	13.105 RZ78	65	245	3	56	18		St 83.50
Zimmertürschild	13.105 PZ78	65	245	3	56	18		St 83.50

**Türgarnitur Serie Altmann**

Eisen naturblank



Bezeichnung	Bestellnummer	H	I	H	ø	Ø	□	CHF
Zimmertürgarnitur								
Zimmertürdrücker	13.160.0	135	60		18	8		Pr 203.00
Drücker-Lochteil links	13.160.2 Ls	135	60		18	8		St 101.50
Drücker-Lochteil rechts	13.160.2 Rs	135	60		18	8		St 101.50
Zimmertürschild	13.161 UG	40	230	3	62	18		St 73.00
Zimmertürschild	13.161 BB78	40	230	3	62	18		St 73.00
Zimmertürschild	13.161 RZ78	40	230	3	62	18		St 73.00
Zimmertürschild	13.161 PZ78	40	230	3	62	18		St 73.00

**Türgarnitur Serie Ochs**

Eisen naturblank



Bezeichnung	Bestellnummer	H	I	H	ø	Ø	□	CHF
Zimmertürgarnitur								
Zimmertürdrücker	13.168.0	110	62		18	8		Pr 203.00
Drücker-Lochteil	13.168.2	110	62		18	8		St 101.50
Zimmertürschild	13.105 UG	65	245	3	56	18		St 83.50
Zimmertürschild	13.105 BB78	65	245	3	56	18		St 83.50
Zimmertürschild	13.105 RZ78	65	245	3	56	18		St 83.50
Zimmertürschild	13.105 PZ78	65	245	3	56	18		St 83.50

Türgarnitur Serie Castor

Eisen naturblank



Bezeichnung	Bestellnummer	H	I	H	ø	Ø	□	CHF
Zimmertürgarnitur								
Zimmertürdrücker	13.170.0	130	58		18	8		Pr 186.00
Drücker-Lochteil links	13.170.2 Ls	130	58		18	8		St 93.00
Drücker-Lochteil rechts	13.170.2 Rs	130	58		18	8		St 93.00
Zimmertürschild	13.171 UG	40	250	2	62	18		St 68.00
Zimmertürschild	13.171 BB78	40	250	2	62	18		St 68.00
Zimmertürschild	13.171 RZ78	40	250	2	62	18		St 68.00
Zimmertürschild	13.171 PZ78	40	250	2	62	18		St 68.00



Türgarnitur Serie Nordend

Eisen naturblank



Bezeichnung	Bestellnummer	H	I	H	ø	Ø	□	CHF
Zimmertürgarnitur								
Zimmertürdrücker	13.181.0	140	75		18	8		Pr 231.00
Drücker-Lochteil	13.181.2	140	75		18	8		St 115.50
Zimmertürschild	13.183 UG	40	230	2	65	18		St 68.00
Zimmertürschild	13.183 BB78	40	230	2	65	18		St 68.00
Zimmertürschild	13.183 RZ78	40	230	2	65	18		St 68.00
Zimmertürschild	13.183 PZ78	40	230	2	65	18		St 68.00



Türgarnitur Serie Mischabel

Eisen naturblank



Bezeichnung	Bestellnummer	H	I	H	ø	Ø	□	CHF
Zimmertürgarnitur								
Zimmertürdrücker	13.182.0	150	62		18	8		Pr 230.00
Drücker-Lochteil links	13.182.2 Ls	150	62		18	8		St 115.00
Drücker-Lochteil rechts	13.182.2 Rs	150	62		18	8		St 115.00
Zimmertürschild	13.183 UG	40	230	2	65	18		St 68.00
Zimmertürschild	13.183 BB78	40	230	2	65	18		St 68.00
Zimmertürschild	13.183 RZ78	40	230	2	65	18		St 68.00
Zimmertürschild	13.183 PZ78	40	230	2	65	18		St 68.00



**Türgarnitur Serie Dom**

Eisen naturblank



Bezeichnung	Bestellnummer	H	I	H	ø	Ø	□	CHF
Zimmertürgarnitur								
Zimmertürdrücker	13.184.0	125		62		18	8	Pr 152.00
Drücker-Lochteil	13.184.2	125		62		18	8	St 76.00
Zimmertürschild	13.187 UG	40	230	2	62	18		St 59.00
Zimmertürschild	13.187 BB78	40	230	2	62	18		St 59.00
Zimmertürschild	13.187 RZ78	40	230	2	62	18		St 59.00
Zimmertürschild	13.187 PZ78	40	230	2	62	18		St 59.00
Haustürgarnitur								
Haustürdrücker	13.184H.0	140		64		18	9	Pr 230.00
Drücker-Lochteil	13.184H.2	140		64		18	9	St 115.00
Haustürschild	13.187H UG	50	250	3	67	18		St 79.50
Haustürschild	13.187H RZ78	50	250	3	67	18		St 79.50
Haustürschild	13.187H PZ78	50	250	3	67	18		St 79.50

**Türgarnitur Serie Pollux**

Eisen naturblank



Bezeichnung	Bestellnummer	H	I	H	ø	□	CHF
Zimmertürgarnitur							
Zimmertürdrücker	13.186.0	120		52	18	8	Pr 179.00
Drücker-Lochteil	13.186.2	120		52	18	8	St 89.50
Zimmertürschild	13.140 UG	65	180	2	18		St 64.50
Zimmertürschild	13.140 BB78	65	180	2	18		St 64.50
Zimmertürschild	13.140 RZ78	65	180	2	18		St 64.50
Zimmertürschild	13.140 PZ78	65	180	2	18		St 64.50

**Türgarnitur Serie Pollux**

Eisen naturblank



Bezeichnung	Bestellnummer	H	I	H	ø	Ø	□	CHF
Zimmertürgarnitur								
Zimmertürdrücker	13.186.0	120		52		18	8	Pr 179.00
Drücker-Lochteil	13.186.2	120		52		18	8	St 89.50
Zimmertürschild	13.187 UG	40	230	2	62	18		St 59.00
Zimmertürschild	13.187 BB78	40	230	2	62	18		St 59.00
Zimmertürschild	13.187 RZ78	40	230	2	62	18		St 59.00
Zimmertürschild	13.187 PZ78	40	230	2	62	18		St 59.00
Haustürgarnitur								
Haustürdrücker	13.186H.0	135		65		18	9	Pr 235.00
Drücker-Lochteil	13.186H.2	135		65		18	9	St 117.50
Haustürschild	13.187H UG	50	250	3	67	18		St 79.50
Haustürschild	13.187H RZ78	50	250	3	67	18		St 79.50
Haustürschild	13.187H PZ78	50	250	3	67	18		St 79.50

Türgarnitur Serie Combin

Eisen naturblank



Bezeichnung	Bestellnummer	H	I	H	Ø	Ø	□	CHF
Zimmertürgarnitur								
Zimmertürdrücker	13.188.0	130		56		18	8	Pr 160.00
Drücker-Lochteil	13.188.2	130		56		18	8	St 80.00
Zimmertürschild	13.191 UG	40	230	2	61	18		St 62.00
Zimmertürschild	13.191 BB78	40	230	2	61	18		St 62.00
Zimmertürschild	13.191 RZ78	40	230	2	61	18		St 62.00
Zimmertürschild	13.191 PZ78	40	230	2	61	18		St 62.00
Haustürgarnitur								
Haustürdrücker	13.188H.0	165		67		18	9	Pr 240.00
Drücker-Lochteil	13.188H.2	165		67		18	9	St 120.00
Haustürschild	13.191H UG	50	250	3	74	18		St 86.00
Haustürschild	13.191H RZ78	50	250	3	74	18		St 86.00
Haustürschild	13.191H PZ78	50	250	3	74	18		St 86.00



Türgarnitur Serie Picco

Eisen naturblank



Bezeichnung	Bestellnummer	H	I	H	Ø	Ø	□	CHF
Zimmertürgarnitur								
Zimmertürdrücker	13.189.0	125		60		18	8	Pr 179.00
Drücker-Lochteil links	13.189.2 Ls	125		60		18	8	St 89.50
Drücker-Lochteil rechts	13.189.2 Rs	125		60		18	8	St 89.50
Zimmertürschild	13.191 UG	40	230	2	61	18		St 62.00
Zimmertürschild	13.191 BB78	40	230	2	61	18		St 62.00
Zimmertürschild	13.191 RZ78	40	230	2	61	18		St 62.00
Zimmertürschild	13.191 PZ78	40	230	2	61	18		St 62.00



Türgarnitur Serie Amiante

Eisen naturblank



Bezeichnung	Bestellnummer	H	I	H	Ø	Ø	□	CHF
Zimmertürgarnitur								
Zimmertürdrücker	13.194.0	125		75		18	8	Pr 212.00
Drücker-Lochteil links	13.194.2 Ls	125		75		18	8	St 106.00
Drücker-Lochteil rechts	13.194.2 Rs	125		75		18	8	St 106.00
Zimmertürschild	13.105 UG	65	245	3	56	18		St 83.50
Zimmertürschild	13.105 BB78	65	245	3	56	18		St 83.50
Zimmertürschild	13.105 RZ78	65	245	3	56	18		St 83.50
Zimmertürschild	13.105 PZ78	65	245	3	56	18		St 83.50





Türgarnitur Serie Zupò

Eisen verzinkt-altpatiniert
mit Hochstellfeder



Bezeichnung	Bestellnummer	H	I	H	Ø	□	∞	CHF
Zimmertürgarnitur								
Zimmertürdrücker	15.142.0	120	60	18	8			Pr 218.00
Drücker-Lochteil	15.142.2	120	60	18	8			St 109.00
Drückerrosette	15.197/18-8mm	54	54	11.5	18	8	38	St 44.50
Schlüsselrosette blind	15.197 UG	54	54	11.5			38	St 44.50
Schlüsselrosette	15.197 BB	54	54	11.5			38	St 44.50
Zylinderrosette	15.197 RZ	54	54	11.5			38	St 44.50
Zylinderrosette	15.197 PZ	54	54	11.5			38	St 44.50
Haustürgarnitur								
Haustürdrücker	15.142H.0	135	60	18	9			Pr 280.00
Drücker-Lochteil	15.142H.2	135	60	18	9			St 140.00
Drückerrosette	15.197/18-9mm	54	54	11.5	18	9	38	St 50.00

Türgarnitur Serie Zupò

Eisen verzinkt-altpatiniert



Bezeichnung	Bestellnummer	H	I	H	Ø	□	∞	CHF
Zimmertürgarnitur								
Zimmertürdrücker	15.142.0	120	60	18	8			Pr 218.00
Drücker-Lochteil	15.142.2	120	60	18	8			St 109.00
Drückerrosette	15.205	52	52	3	18		38	St 46.00
Schlüsselrosette blind	15.205 UG	52	52	3			38	St 46.00
Schlüsselrosette	15.205 BB	52	52	3			38	St 46.00
Zylinderrosette	15.205 RZ	52	52	3			38	St 46.00
Zylinderrosette	15.205 PZ	52	52	3			38	St 46.00
Haustürgarnitur								
Haustürdrücker	15.142H.0	135	60	18	9			Pr 280.00
Drücker-Lochteil	15.142H.2	135	60	18	9			St 140.00
Drückerrosette	15.205H	58	58	3	18		38	St 54.50
Schlüsselrosette blind	15.205H UG	58	58	3			38	St 54.50
Zylinderrosette	15.205H RZ	58	58	3			38	St 54.50
Zylinderrosette	15.205H PZ	58	58	3			38	St 54.50

Türgarnitur Serie Alv

Eisen verzinkt-altpatiniert
mit Hochstellfeder



Bezeichnung	Bestellnummer	H	I	H	Ø	□	∞	CHF
Zimmertürgarnitur								
Zimmertürdrücker	15.144.0	120	50	18	8			Pr 216.00
Drücker-Lochteil	15.144.2	120	50	18	8			St 108.00
Drückerrosette	15.200/18-8mm	53	53	11.5	18	8	38	St 44.50
Schlüsselrosette blind	15.200 UG	53	53	11.5			38	St 44.50
Schlüsselrosette	15.200 BB	53	53	11.5			38	St 44.50
Zylinderrosette	15.200 RZ	53	53	11.5			38	St 44.50
Zylinderrosette	15.200 PZ	53	53	11.5			38	St 44.50
Haustürgarnitur								
Haustürdrücker	15.144H.0	130	55	18	9			Pr 278.00
Drücker-Lochteil	15.144H.2	130	55	18	9			St 139.00
Drückerrosette	15.200/18-9mm	53	53	11.5	18	9	38	St 50.00

Türgarnitur Serie Zinal

Eisen verzinkt-altpatiniert
mit Hochstellfeder



Bezeichnung	Bestellnummer	H	I	H	Ø	∇	∞	CHF
Zimmertürgarnitur								
Zimmertürdrücker	15.145.0	120		53	18	8		Pr 208.00
Drücker-Lochteil	15.145.2	120		53	18	8		St 104.00
Drückerrosette	15.200/18-8mm	53	53	11.5	18	8	38	St 44.50
Schlüsselrosette blind	15.200 UG	53	53	11.5			38	St 44.50
Schlüsselrosette	15.200 BB	53	53	11.5			38	St 44.50
Zylinderrosette	15.200 RZ	53	53	11.5			38	St 44.50
Zylinderrosette	15.200 PZ	53	53	11.5			38	St 44.50



Türgarnitur Serie Spedia

Eisen verzinkt-altpatiniert



Bezeichnung	Bestellnummer	H	I	H	Ø	∇	∞	CHF
Zimmertürgarnitur								
Zimmertürdrücker	15.146.0	122		55	18	8		Pr 214.00
Drücker-Lochteil	15.146.2	122		55	18	8		St 107.00
Drückerrosette	15.205	52	52	3	18		38	St 46.00
Schlüsselrosette blind	15.205 UG	52	52	3			38	St 46.00
Schlüsselrosette	15.205 BB	52	52	3			38	St 46.00
Zylinderrosette	15.205 RZ	52	52	3			38	St 46.00
Zylinderrosette	15.205 PZ	52	52	3			38	St 46.00
Haustürgarnitur								
Haustürdrücker	15.146H.0	135		55	18	9		Pr 272.00
Drücker-Lochteil	15.146H.2	135		55	18	9		St 136.00
Drückerrosette	15.205H	58	58	3	18		38	St 54.50
Schlüsselrosette blind	15.205H UG	58	58	3			38	St 54.50
Zylinderrosette	15.205H RZ	58	58	3			38	St 54.50
Zylinderrosette	15.205H PZ	58	58	3			38	St 54.50



Türgarnitur Serie Besso

Eisen verzinkt-altpatiniert



Bezeichnung	Bestellnummer	H	I	H	Ø	∇	∞	CHF
Zimmertürgarnitur								
Zimmertürdrücker	15.148.0	120		59	18	8		Pr 198.00
Drücker-Lochteil	15.148.2	120		59	18	8		St 99.00
Drückerrosette	15.205	52	52	3	18		38	St 46.00
Schlüsselrosette blind	15.205 UG	52	52	3			38	St 46.00
Schlüsselrosette	15.205 BB	52	52	3			38	St 46.00
Zylinderrosette	15.205 RZ	52	52	3			38	St 46.00
Zylinderrosette	15.205 PZ	52	52	3			38	St 46.00



Türgarnitur Serie Pollux

Eisen verzinkt-altpatiniert



Bezeichnung	Bestellnummer	H	H	Ø	∇	∞	CHF
Zimmertürgarnitur							
Zimmertürdrücker	15.186.0	120	52	18	8		Pr 209.00
Drücker-Lochteil	15.186.2	120	52	18	8		St 104.50
Drückerrosette	15.198	60	3	18		38	St 46.00
Schlüsselrosette blind	15.198 UG	60	3			38	St 46.00
Schlüsselrosette	15.198 BB	60	3			38	St 46.00
Zylinderrosette	15.198 RZ	60	3			38	St 46.00
Zylinderrosette	15.198 PZ	60	3			38	St 46.00
Haustürgarnitur							
Haustürdrücker	15.186H.0	135	65	18	9		Pr 265.00
Drücker-Lochteil	15.186H.2	135	65	18	9		St 132.50



**Türgarnitur Serie Combin**Eisen verzinkt-altpatiniert
mit Hochstellfeder

Bezeichnung	Bestellnummer	H	I	H	Ø	□	⊙	CHF
Zimmertürgarnitur								
Zimmertürdrücker	15.188.0	130	56	18	8			Pr 190.00
Drücker-Lochteil	15.188.2	130	56	18	8			St 95.00
Drückerrosette	15.197/18-8mm	54	54	11.5	18	8	38	St 44.50
Schlüsselrosette blind	15.197 UG	54	54	11.5			38	St 44.50
Schlüsselrosette	15.197 BB	54	54	11.5			38	St 44.50
Zylinderrosette	15.197 RZ	54	54	11.5			38	St 44.50
Zylinderrosette	15.197 PZ	54	54	11.5			38	St 44.50
Haustürgarnitur								
Haustürdrücker	15.188H.0	165	67	18	9			Pr 270.00
Drücker-Lochteil	15.188H.2	165	67	18	9			St 135.00
Drückerrosette	15.197/18-9mm	54	54	11.5	18	9	38	St 50.00

**Haustürgarnitur Serie Bellavista**

Eisen verzinkt-altpatiniert



Bezeichnung	Bestellnummer	H	I	H	Ø	□	CHF
Haustürgarnitur							
Haustürdrücker	15.100H.0	145	75	18	9		Pr 294.00
Drücker-Lochteil links	15.100H.2 Ls	145	75	18	9		St 147.00
Drücker-Lochteil rechts	15.100H.2 Rs	145	75	18	9		St 147.00
Haustürschild	15.101H UG	85	300	3	86	18	St 125.00
Haustürschild	15.101H RZ78	85	300	3	86	18	St 125.00
Haustürschild	15.101H PZ78	85	300	3	86	18	St 125.00

**Haustürgarnitur Serie Roseg**

Eisen verzinkt-altpatiniert



Bezeichnung	Bestellnummer	H	I	H	Ø	□	CHF
Haustürgarnitur							
Haustürdrücker	15.132H.0	150	63	18	9		Pr 304.00
Drücker-Lochteil links	15.132H.2 Ls	150	63	18	9		St 152.00
Drücker-Lochteil rechts	15.132H.2 Rs	150	63	18	9		St 152.00
Haustürschild	15.133H UG	50	255	3	77	18	St 118.00
Haustürschild	15.133H RZ78	50	255	3	77	18	St 118.00
Haustürschild	15.133H PZ78	50	255	3	77	18	St 118.00

Türgarnitur Serie Zupò

Eisen verzinkt-altpatiniert



Bezeichnung	Bestellnummer	H	I	H	Ø	Ø	□	CHF
Zimmertürgarnitur								
Zimmertürdrücker	15.142.0	120	60		18	8		Pr 218.00
Drücker-Lochteil	15.142.2	120	60		18	8		St 109.00
Zimmertürschild	15.147 UG	40	230	2	66	18		St 72.50
Zimmertürschild	15.147 BB78	40	230	2	66	18		St 72.50
Zimmertürschild	15.147 RZ78	40	230	2	66	18		St 72.50
Zimmertürschild	15.147 PZ78	40	230	2	66	18		St 72.50
Haustürgarnitur								
Haustürdrücker	15.142H.0	135	60		18	9		Pr 280.00
Drücker-Lochteil	15.142H.2	135	60		18	9		St 140.00
Haustürschild	15.147H UG	50	250	3	76	18		St 94.50
Haustürschild	15.147H RZ78	50	250	3	76	18		St 94.50
Haustürschild	15.147H PZ78	50	250	3	76	18		St 94.50



Türgarnitur Serie Alv

Eisen verzinkt-altpatiniert



Bezeichnung	Bestellnummer	H	I	H	Ø	Ø	□	CHF
Zimmertürgarnitur								
Zimmertürdrücker	15.144.0	120	50		18	8		Pr 216.00
Drücker-Lochteil	15.144.2	120	50		18	8		St 108.00
Zimmertürschild	15.147 UG	40	230	2	66	18		St 72.50
Zimmertürschild	15.147 BB78	40	230	2	66	18		St 72.50
Zimmertürschild	15.147 RZ78	40	230	2	66	18		St 72.50
Zimmertürschild	15.147 PZ78	40	230	2	66	18		St 72.50
Haustürgarnitur								
Haustürdrücker	15.144H.0	130	55		18	9		Pr 278.00
Drücker-Lochteil	15.144H.2	130	55		18	9		St 139.00
Haustürschild	15.147H UG	50	250	3	76	18		St 94.50
Haustürschild	15.147H RZ78	50	250	3	76	18		St 94.50
Haustürschild	15.147H PZ78	50	250	3	76	18		St 94.50



Türgarnitur Serie Zinal

Eisen verzinkt-altpatiniert



Bezeichnung	Bestellnummer	H	I	H	Ø	Ø	□	CHF
Zimmertürgarnitur								
Zimmertürdrücker	15.145.0	120	53		18	8		Pr 208.00
Drücker-Lochteil	15.145.2	120	53		18	8		St 104.00
Zimmertürschild	15.147 UG	40	230	2	66	18		St 72.50
Zimmertürschild	15.147 BB78	40	230	2	66	18		St 72.50
Zimmertürschild	15.147 RZ78	40	230	2	66	18		St 72.50
Zimmertürschild	15.147 PZ78	40	230	2	66	18		St 72.50



**Türgarnitur Serie Spedia**

Eisen verzinkt-altpatiniert



Bezeichnung	Bestellnummer	H	I	H	ø	Ø	□	CHF
Zimmertürgarnitur								
Zimmertürdrücker	15.146.0	122	55		18	8		Pr 214.00
Drücker-Lochteil	15.146.2	122	55		18	8		St 107.00
Zimmertürschild	15.147 UG	40	230	2	66	18		St 72.50
Zimmertürschild	15.147 BB78	40	230	2	66	18		St 72.50
Zimmertürschild	15.147 RZ78	40	230	2	66	18		St 72.50
Zimmertürschild	15.147 PZ78	40	230	2	66	18		St 72.50
Haustürgarnitur								
Haustürdrücker	15.146H.0	135	55		18	9		Pr 272.00
Drücker-Lochteil	15.146H.2	135	55		18	9		St 136.00
Haustürschild	15.147H UG	50	250	3	76	18		St 94.50
Haustürschild	15.147H RZ78	50	250	3	76	18		St 94.50
Haustürschild	15.147H PZ78	50	250	3	76	18		St 94.50

**Türgarnitur Serie Besso**

Eisen verzinkt-altpatiniert



Bezeichnung	Bestellnummer	H	I	H	ø	Ø	□	CHF
Zimmertürgarnitur								
Zimmertürdrücker	15.148.0	120	59		18	8		Pr 198.00
Drücker-Lochteil	15.148.2	120	59		18	8		St 99.00
Zimmertürschild	15.147 UG	40	230	2	66	18		St 72.50
Zimmertürschild	15.147 BB78	40	230	2	66	18		St 72.50
Zimmertürschild	15.147 RZ78	40	230	2	66	18		St 72.50
Zimmertürschild	15.147 PZ78	40	230	2	66	18		St 72.50

**Haustürgarnitur Serie Altels**

Eisen verzinkt-altpatiniert



Bezeichnung	Bestellnummer	H	I	H	ø	Ø	□	CHF
Haustürgarnitur								
Haustürdrücker	15.152H.0	120	95		18	9		Pr 310.00
Drücker-Lochteil links	15.152H.2 Ls	120	95		18	9		St 155.00
Drücker-Lochteil rechts	15.152H.2 Rs	120	95		18	9		St 155.00
Haustürschild	15.105H UG	70	250	3	65	18		St 117.00
Haustürschild	15.105H RZ78	70	250	3	65	18		St 117.00
Haustürschild	15.105H PZ78	70	250	3	65	18		St 117.00

Haustürgarnitur Serie Altmann

Eisen verzinkt-altpatiniert



Bezeichnung	Bestellnummer	H	I	H	Ø	Ø	□	CHF
Haustürgarnitur								
Haustürdrücker	15.160H.0	140	60		18	9		Pr 306.00
Drücker-Lochteil links	15.160H.2 Ls	140	60		18	9		St 153.00
Drücker-Lochteil rechts	15.160H.2 Rs	140	60		18	9		St 153.00
Haustürschild	15.161H UG	50	250	3	72	18		St 114.00
Haustürschild	15.161H RZ78	50	250	3	72	18		St 114.00
Haustürschild	15.161H PZ78	50	250	3	72	18		St 114.00



Haustürgarnitur Serie Castor

Eisen verzinkt-altpatiniert



Bezeichnung	Bestellnummer	H	I	H	Ø	Ø	□	CHF
Haustürgarnitur								
Haustürdrücker	15.170H.0	150	60		18	9		Pr 272.00
Drücker-Lochteil links	15.170H.2 Ls	150	60		18	9		St 136.00
Drücker-Lochteil rechts	15.170H.2 Rs	150	60		18	9		St 136.00
Haustürschild	15.171H UG	50	260	3	64	18		St 110.00
Haustürschild	15.171H RZ78	50	260	3	64	18		St 110.00
Haustürschild	15.171H PZ78	50	260	3	64	18		St 110.00



Türgarnitur Serie Dom

Eisen verzinkt-altpatiniert



Bezeichnung	Bestellnummer	H	I	H	Ø	Ø	□	CHF
Zimmertürgarnitur								
Zimmertürdrücker	15.184.0	125	62		18	8		Pr 182.00
Drücker-Lochteil	15.184.2	125	62		18	8		St 91.00
Zimmertürschild	15.187 UG	40	230	2	62	18		St 74.00
Zimmertürschild	15.187 BB78	40	230	2	62	18		St 74.00
Zimmertürschild	15.187 RZ78	40	230	2	62	18		St 74.00
Zimmertürschild	15.187 PZ78	40	230	2	62	18		St 74.00
Haustürgarnitur								
Haustürdrücker	15.184H.0	140	64		18	9		Pr 260.00
Drücker-Lochteil	15.184H.2	140	64		18	9		St 130.00
Haustürschild	15.187H UG	50	250	3	67	18		St 94.50
Haustürschild	15.187H RZ78	50	250	3	67	18		St 94.50
Haustürschild	15.187H PZ78	50	250	3	67	18		St 94.50



**Türgarnitur Serie Pollux**

Eisen verzinkt-altpatiniert

Bezeichnung	Bestellnummer	H	I	H	ø	Ø	□	CHF
Zimmertürgarnitur								
Zimmertürdrücker	15.186.0	120	52		18	8		Pr 209.00
Drücker-Lochteil	15.186.2	120	52		18	8		St 104.50
Zimmertürschild	15.187 UG	40	230	2	62	18		St 74.00
Zimmertürschild	15.187 BB78	40	230	2	62	18		St 74.00
Zimmertürschild	15.187 RZ78	40	230	2	62	18		St 74.00
Zimmertürschild	15.187 PZ78	40	230	2	62	18		St 74.00
Haustürgarnitur								
Haustürdrücker	15.186H.0	135	65		18	9		Pr 265.00
Drücker-Lochteil	15.186H.2	135	65		18	9		St 132.50
Haustürschild	15.187H UG	50	250	3	67	18		St 94.50
Haustürschild	15.187H RZ78	50	250	3	67	18		St 94.50
Haustürschild	15.187H PZ78	50	250	3	67	18		St 94.50

**Türgarnitur Serie Combin**

Eisen verzinkt-altpatiniert

Bezeichnung	Bestellnummer	H	I	H	ø	Ø	□	CHF
Zimmertürgarnitur								
Zimmertürdrücker	15.188.0	130	56		18	8		Pr 190.00
Drücker-Lochteil	15.188.2	130	56		18	8		St 95.00
Zimmertürschild	15.191 UG	40	230	2	61	18		St 77.00
Zimmertürschild	15.191 BB78	40	230	2	61	18		St 77.00
Zimmertürschild	15.191 RZ78	40	230	2	61	18		St 77.00
Zimmertürschild	15.191 PZ78	40	230	2	61	18		St 77.00
Haustürgarnitur								
Haustürdrücker	15.188H.0	165	67		18	9		Pr 270.00
Drücker-Lochteil	15.188H.2	165	67		18	9		St 135.00
Haustürschild	15.191H UG	50	250	3	74	18		St 101.00
Haustürschild	15.191H RZ78	50	250	3	74	18		St 101.00
Haustürschild	15.191H PZ78	50	250	3	74	18		St 101.00

**Haustürgarnitur Serie Amiante**

Eisen verzinkt-altpatiniert

Bezeichnung	Bestellnummer	H	I	H	ø	Ø	□	CHF
Haustürgarnitur								
Haustürdrücker	15.194H.0	150	80		18	9		Pr 337.00
Drücker-Lochteil links	15.194H.2 Ls	150	80		18	9		St 168.50
Drücker-Lochteil rechts	15.194H.2 Rs	150	80		18	9		St 168.50
Haustürschild	15.105H UG	70	250	3	65	18		St 117.00
Haustürschild	15.105H RZ78	70	250	3	65	18		St 117.00
Haustürschild	15.105H PZ78	70	250	3	65	18		St 117.00

Türgarnitur Serie Zupò

Eisen gerostet
mit Hochstellfeder



Bezeichnung	Bestellnummer	H	I	H	Ø	∇	∞	CHF
Zimmertürgarnitur								
Zimmertürdrücker	16.142.0	120	60	18	8			Pr 230.00
Drücker-Lochteil	16.142.2	120	60	18	8			St 115.00
Drückerrosette	16.197/18-8mm	54	54	11.5	18	8	38	St 45.00
Schlüsselrosette blind	16.197 UG	54	54	11.5			38	St 45.00
Schlüsselrosette	16.197 BB	54	54	11.5			38	St 45.00
Zylinderrosette	16.197 RZ	54	54	11.5			38	St 45.00
Zylinderrosette	16.197 PZ	54	54	11.5			38	St 45.00



Türgarnitur Serie Alv

Eisen gerostet
mit Hochstellfeder



Bezeichnung	Bestellnummer	H	I	H	Ø	∇	∞	CHF
Zimmertürgarnitur								
Zimmertürdrücker	16.144.0	120	50	18	8			Pr 228.00
Drücker-Lochteil	16.144.2	120	50	18	8			St 114.00
Drückerrosette	16.200/18-8mm	53	53	11.5	18	8	38	St 45.00
Schlüsselrosette blind	16.200 UG	53	53	11.5			38	St 45.00
Schlüsselrosette	16.200 BB	53	53	11.5			38	St 45.00
Zylinderrosette	16.200 RZ	53	53	11.5			38	St 45.00
Zylinderrosette	16.200 PZ	53	53	11.5			38	St 45.00



Türgarnitur Serie Zinal

Eisen gerostet
mit Hochstellfeder



Bezeichnung	Bestellnummer	H	I	H	Ø	∇	∞	CHF
Zimmertürgarnitur								
Zimmertürdrücker	16.145.0	120	53	18	8			Pr 220.00
Drücker-Lochteil	16.145.2	120	53	18	8			St 110.00
Drückerrosette	16.200/18-8mm	53	53	11.5	18	8	38	St 45.00
Schlüsselrosette blind	16.200 UG	53	53	11.5			38	St 45.00
Schlüsselrosette	16.200 BB	53	53	11.5			38	St 45.00
Zylinderrosette	16.200 RZ	53	53	11.5			38	St 45.00
Zylinderrosette	16.200 PZ	53	53	11.5			38	St 45.00



Türgarnitur Serie Spedia

Eisen gerostet



Bezeichnung	Bestellnummer	H	I	H	Ø	∇	∞	CHF
Zimmertürgarnitur								
Zimmertürdrücker	16.146.0	122	55	18	8			Pr 226.00
Drücker-Lochteil	16.146.2	122	55	18	8			St 113.00
Drückerrosette	16.205	52	52	3	18		38	St 46.50
Schlüsselrosette blind	16.205 UG	52	52	3			38	St 46.50
Schlüsselrosette	16.205 BB	52	52	3			38	St 46.50
Zylinderrosette	16.205 RZ	52	52	3			38	St 46.50
Zylinderrosette	16.205 PZ	52	52	3			38	St 46.50



**Türgarnitur Serie Besso**

Eisen gerostet

Bezeichnung	Bestellnummer	H	I	H	Ø	□	∞	CHF
Zimmertürgarnitur								
Zimmertürdrücker	16.148.0	120		59	18	8		Pr 210.00
Drücker-Lochteil	16.148.2	120		59	18	8		St 105.00
Drückerrosette	16.205	52	52	3	18		38	St 46.50
Schlüsselrosette blind	16.205 UG	52	52	3			38	St 46.50
Schlüsselrosette	16.205 BB	52	52	3			38	St 46.50
Zylinderrosette	16.205 RZ	52	52	3			38	St 46.50
Zylinderrosette	16.205 PZ	52	52	3			38	St 46.50

Türgarnitur Serie Pollux

Eisen gerostet

Bezeichnung	Bestellnummer	H	H	Ø	□	∞	CHF
Zimmertürgarnitur							
Zimmertürdrücker	16.186.0	120	52	18	8		Pr 221.00
Drücker-Lochteil	16.186.2	120	52	18	8		St 110.50
Drückerrosette	16.198	60	3	18		38	St 46.50
Schlüsselrosette blind	16.198 UG	60	3			38	St 46.50
Schlüsselrosette	16.198 BB	60	3			38	St 46.50
Zylinderrosette	16.198 RZ	60	3			38	St 46.50
Zylinderrosette	16.198 PZ	60	3			38	St 46.50

Türgarnitur Serie CombinEisen gerostet
mit Hochstellfeder

Bezeichnung	Bestellnummer	H	I	H	Ø	□	∞	CHF
Zimmertürgarnitur								
Zimmertürdrücker	16.188.0	130		56	18	8		Pr 202.00
Drücker-Lochteil	16.188.2	130		56	18	8		St 101.00
Drückerrosette	16.197/18-8mm	54	54	11.5	18	8	38	St 45.00
Schlüsselrosette blind	16.197 UG	54	54	11.5			38	St 45.00
Schlüsselrosette	16.197 BB	54	54	11.5			38	St 45.00
Zylinderrosette	16.197 RZ	54	54	11.5			38	St 45.00
Zylinderrosette	16.197 PZ	54	54	11.5			38	St 45.00

Türgarnitur Serie Roseg

Eisen gerostet



Bezeichnung	Bestellnummer	H	I	H	Ø	Ø	□	CHF
Zimmertürgarnitur								
Zimmertürdrücker	16.132.0	115	60		18	8		Pr 243.00
Drücker-Lochteil links	16.132.2 Ls	115	60		18	8		St 121.50
Drücker-Lochteil rechts	16.132.2 Rs	115	60		18	8		St 121.50
Zimmertürschild	16.133 UG	40	233	2	67	18		St 89.00
Zimmertürschild	16.133 BB78	40	233	2	67	18		St 89.00
Zimmertürschild	16.133 RZ78	40	233	2	67	18		St 89.00
Zimmertürschild	16.133 PZ78	40	233	2	67	18		St 89.00



Türgarnitur Serie Zupò

Eisen gerostet



Bezeichnung	Bestellnummer	H	I	H	Ø	Ø	□	CHF
Zimmertürgarnitur								
Zimmertürdrücker	16.142.0	120	60		18	8		Pr 230.00
Drücker-Lochteil	16.142.2	120	60		18	8		St 115.00
Zimmertürschild	16.147 UG	40	230	2	66	18		St 78.50
Zimmertürschild	16.147 BB78	40	230	2	66	18		St 78.50
Zimmertürschild	16.147 RZ78	40	230	2	66	18		St 78.50
Zimmertürschild	16.147 PZ78	40	230	2	66	18		St 78.50



Türgarnitur Serie Alv

Eisen gerostet



Bezeichnung	Bestellnummer	H	I	H	Ø	Ø	□	CHF
Zimmertürgarnitur								
Zimmertürdrücker	16.144.0	120	50		18	8		Pr 228.00
Drücker-Lochteil	16.144.2	120	50		18	8		St 114.00
Zimmertürschild	16.147 UG	40	230	2	66	18		St 78.50
Zimmertürschild	16.147 BB78	40	230	2	66	18		St 78.50
Zimmertürschild	16.147 RZ78	40	230	2	66	18		St 78.50
Zimmertürschild	16.147 PZ78	40	230	2	66	18		St 78.50



**Türgarnitur Serie Zinal**

Eisen gerostet



Bezeichnung	Bestellnummer	H	I	H	Ø	Ø	Ø	CHF
Zimmertürgarnitur								
Zimmertürdrücker	16.145.0	120		53		18	8	Pr 220.00
Drücker-Lochteil	16.145.2	120		53		18	8	St 110.00
Zimmertürschild	16.147 UG	40	230	2	66	18		St 78.50
Zimmertürschild	16.147 BB78	40	230	2	66	18		St 78.50
Zimmertürschild	16.147 RZ78	40	230	2	66	18		St 78.50
Zimmertürschild	16.147 PZ78	40	230	2	66	18		St 78.50

**Türgarnitur Serie Spedia**

Eisen gerostet



Bezeichnung	Bestellnummer	H	I	H	Ø	Ø	Ø	CHF
Zimmertürgarnitur								
Zimmertürdrücker	16.146.0	122		55		18	8	Pr 226.00
Drücker-Lochteil	16.146.2	122		55		18	8	St 113.00
Zimmertürschild	16.147 UG	40	230	2	66	18		St 78.50
Zimmertürschild	16.147 BB78	40	230	2	66	18		St 78.50
Zimmertürschild	16.147 RZ78	40	230	2	66	18		St 78.50
Zimmertürschild	16.147 PZ78	40	230	2	66	18		St 78.50

**Türgarnitur Serie Besso**

Eisen gerostet



Bezeichnung	Bestellnummer	H	I	H	Ø	Ø	Ø	CHF
Zimmertürgarnitur								
Zimmertürdrücker	16.148.0	120		59		18	8	Pr 210.00
Drücker-Lochteil	16.148.2	120		59		18	8	St 105.00
Zimmertürschild	16.147 UG	40	230	2	66	18		St 78.50
Zimmertürschild	16.147 BB78	40	230	2	66	18		St 78.50
Zimmertürschild	16.147 RZ78	40	230	2	66	18		St 78.50
Zimmertürschild	16.147 PZ78	40	230	2	66	18		St 78.50

Türgarnitur Serie Dom

Eisen gerostet



Bezeichnung	Bestellnummer	H	I	H	Ø	Ø	□	CHF
Zimmertürgarnitur								
Zimmertürdrücker	16.184.0	125		62		18	8	Pr 194.00
Drücker-Lochteil	16.184.2	125		62		18	8	St 97.00
Zimmertürschild	16.187 UG	40	230	2	62	18		St 80.00
Zimmertürschild	16.187 BB78	40	230	2	62	18		St 80.00
Zimmertürschild	16.187 RZ78	40	230	2	62	18		St 80.00
Zimmertürschild	16.187 PZ78	40	230	2	62	18		St 80.00



Türgarnitur Serie Pollux

Eisen gerostet



Bezeichnung	Bestellnummer	H	I	H	Ø	Ø	□	CHF
Zimmertürgarnitur								
Zimmertürdrücker	16.186.0	120		52		18	8	Pr 221.00
Drücker-Lochteil	16.186.2	120		52		18	8	St 110.50
Zimmertürschild	16.187 UG	40	230	2	62	18		St 80.00
Zimmertürschild	16.187 BB78	40	230	2	62	18		St 80.00
Zimmertürschild	16.187 RZ78	40	230	2	62	18		St 80.00
Zimmertürschild	16.187 PZ78	40	230	2	62	18		St 80.00



Türgarnitur Serie Combin

Eisen gerostet



Bezeichnung	Bestellnummer	H	I	H	Ø	Ø	□	CHF
Zimmertürgarnitur								
Zimmertürdrücker	16.188.0	130		56		18	8	Pr 202.00
Drücker-Lochteil	16.188.2	130		56		18	8	St 101.00
Zimmertürschild	16.191 UG	40	230	2	61	18		St 83.00
Zimmertürschild	16.191 BB78	40	230	2	61	18		St 83.00
Zimmertürschild	16.191 RZ78	40	230	2	61	18		St 83.00
Zimmertürschild	16.191 PZ78	40	230	2	61	18		St 83.00





Türgarnitur Serie Spes

Bronze dunkel
mit Hochstellfeder



Bezeichnung	Bestellnummer	H	H	Ø	□	∞	CHF
Zimmertürgarnitur							
Zimmertürdrücker	80.1103.0	160	55	16	8		Pr 270.00
Drücker-Lochteil links	80.1103.2 Ls	160	55	16	8		St 135.00
Drücker-Lochteil rechts	80.1103.2 Rs	160	55	16	8		St 135.00
Drückerrosette	80.1538	54	12	16		38	St 55.00
Schlüsselrosette	80.1538 BB	54	11.5			38	St 55.00
Zylinderrosette	80.1538 RZ	54	11.5			38	St 55.00
Zylinderrosette	80.1538 PZ	54	11.5			38	St 55.00
WC-Rosetten	80.1538 SK/OL	54	43/18		7	38	Pr 220.00

Türgarnitur Serie Quadrum

Bronze dunkel
mit Hochstellfeder



Bezeichnung	Bestellnummer	H	H	Ø	□	∞	CHF
Zimmertürgarnitur							
Zimmertürdrücker	80.1135.0	127	54	16	8		Pr 270.00
Drücker-Lochteil	80.1135.2	127	54	16	8		St 135.00
Drückerrosette	80.1538	54	12	16		38	St 55.00
Schlüsselrosette	80.1538 BB	54	11.5			38	St 55.00
Zylinderrosette	80.1538 RZ	54	11.5			38	St 55.00
Zylinderrosette	80.1538 PZ	54	11.5			38	St 55.00
WC-Rosetten	80.1538 SK/OL	54	43/18		7	38	Pr 220.00

Türgarnitur Serie Latus

Bronze dunkel
mit Hochstellfeder



Bezeichnung	Bestellnummer	H	H	Ø	□	∞	CHF
Zimmertürgarnitur							
Zimmertürdrücker	80.1138.0	135	67	16	8		Pr 270.00
Drücker-Lochteil	80.1138.2	135	67	16	8		St 135.00
Drückerrosette	80.1538	54	12	16		38	St 55.00
Schlüsselrosette	80.1538 BB	54	11.5			38	St 55.00
Zylinderrosette	80.1538 RZ	54	11.5			38	St 55.00
Zylinderrosette	80.1538 PZ	54	11.5			38	St 55.00
WC-Rosetten	80.1538 SK/OL	54	43/18		7	38	Pr 220.00

Türgarnitur Serie Simplex

Bronze dunkel
mit Hochstellfeder



Bezeichnung	Bestellnummer	H	H	Ø	□	∞	CHF
Zimmertürgarnitur							
Zimmertürdrücker	80.1139.0	140	53	16	8		Pr 270.00
Drücker-Lochteil	80.1139.2	140	53	16	8		St 135.00
Drückerrosette	80.1538	54	12	16		38	St 55.00
Schlüsselrosette	80.1538 BB	54	11.5			38	St 55.00
Zylinderrosette	80.1538 RZ	54	11.5			38	St 55.00
Zylinderrosette	80.1538 PZ	54	11.5			38	St 55.00
WC-Rosetten	80.1538 SK/OL	54	43/18		7	38	Pr 220.00

Türgarnitur Serie Suculus

Bronze dunkel
mit Hochstellfeder



Bezeichnung	Bestellnummer	H	H	Ø	□	∞	CHF
Zimmertürgarnitur							
Zimmertürdrücker	80.1139R.0	140	53	16	8		Pr 340.00
Drücker-Lochteil	80.1139R.2	140	53	16	8		St 170.00
Drückerrosette	80.1538	54	12	16		38	St 55.00
Schlüsselrosette	80.1538 BB	54	11.5			38	St 55.00
Zylinderrosette	80.1538 RZ	54	11.5			38	St 55.00
Zylinderrosette	80.1538 PZ	54	11.5			38	St 55.00
WC-Rosetten	80.1538 SK/OL	54	43/18		7	38	Pr 220.00



Türgarnitur Serie Angulum

Bronze dunkel
mit Hochstellfeder



Bezeichnung	Bestellnummer	H	H	Ø	□	∞	CHF
Zimmertürgarnitur							
Zimmertürdrücker	80.1144.0	137	46	16	8		Pr 270.00
Drücker-Lochteil	80.1144.2	137	46	16	8		St 135.00
Drückerrosette	80.1538	54	12	16		38	St 55.00
Schlüsselrosette	80.1538 BB	54	11.5			38	St 55.00
Zylinderrosette	80.1538 RZ	54	11.5			38	St 55.00
Zylinderrosette	80.1538 PZ	54	11.5			38	St 55.00
WC-Rosetten	80.1538 SK/OL	54	43/18		7	38	Pr 220.00



Türgarnitur Serie Tempus

Bronze dunkel
mit Hochstellfeder



Bezeichnung	Bestellnummer	H	H	Ø	□	∞	CHF
Zimmertürgarnitur							
Zimmertürdrücker	80.1155.0	130	67	16	8		Pr 270.00
Drücker-Lochteil	80.1155.2	130	67	16	8		St 135.00
Drückerrosette	80.1548	55	12			38	St 55.00
Schlüsselrosette	80.1548 BB	55	11.5			38	St 55.00
Zylinderrosette	80.1548 PZ	55	11.5			38	St 55.00
Zylinderrosette	80.1548 RZ	55	11.5			38	St 55.00
WC-Rosetten	80.1548 SK/OL	55	41/18		7	38	Pr 220.00



Türgarnitur Serie Pax

Bronze dunkel
mit Hochstellfeder



Bezeichnung	Bestellnummer	H	H	Ø	□	∞	CHF
Zimmertürgarnitur							
Zimmertürdrücker	80.1294.0	130	48	16	8		Pr 270.00
Drücker-Lochteil links	80.1294.2 Ls	130	48	16	8		St 135.00
Drücker-Lochteil rechts	80.1294.2 Rs	130	48	16	8		St 135.00
Drückerrosette	80.1548	55	12			38	St 55.00
Schlüsselrosette	80.1548 BB	55	11.5			38	St 55.00
Zylinderrosette	80.1548 PZ	55	11.5			38	St 55.00
Zylinderrosette	80.1548 RZ	55	11.5			38	St 55.00
WC-Rosetten	80.1548 SK/OL	55	41/18		7	38	Pr 220.00



**Türgarnitur Serie Spes**Bronze dunkel
mit Hochstellfeder

Bezeichnung	Bestellnummer	H	I	H	∅	∅	∅	CHF
Zimmertürgarnitur								
Zimmertürdrücker	80.1103.0	160		55	16	8		Pr 270.00
Drücker-Lochteil links	80.1103.2 Ls	160		55	16	8		St 135.00
Drücker-Lochteil rechts	80.1103.2 Rs	160		55	16	8		St 135.00
Zimmertürschild	80.1180 UG	48	262	15	92	16		St 135.00
Zimmertürschild	80.1180 BB78	48	262	15	92	16		St 135.00
Zimmertürschild	80.1180 RZ78	48	262	15	92	16		St 135.00
Zimmertürschild	80.1180 PZ78	48	262	15	92	16		St 135.00
Zimmertürschilder WC	80.1180 SK/OL78	48	262	15	92	16		Pr 380.00

**Türgarnitur Serie Quadrum**

Bronze dunkel



Bezeichnung	Bestellnummer	H	I	H	∅	∅	∅	CHF
Zimmertürgarnitur								
Zimmertürdrücker	80.1135.0	127		54	16	8		Pr 270.00
Drücker-Lochteil	80.1135.2	127		54	16	8		St 135.00
Zimmertürschild	80.1044 UG	40	230	4	80	16		St 110.00
Zimmertürschild	80.1044 BB78	40	230	4	80	16		St 110.00
Zimmertürschild	80.1044 RZ78	40	230	4	80	16		St 110.00
Zimmertürschild	80.1044 PZ78	40	230	4	80	16		St 110.00
Zimmertürschilder WC	80.1044 SK/OL78	40	230	4	80	16		Pr 330.00

**Türgarnitur Serie Latus**Bronze dunkel
mit Hochstellfeder

Bezeichnung	Bestellnummer	H	I	H	∅	∅	∅	CHF
Zimmertürgarnitur								
Zimmertürdrücker	80.1138.0	135		67	16	8		Pr 270.00
Drücker-Lochteil	80.1138.2	135		67	16	8		St 135.00
Zimmertürschild	80.1180 UG	48	262	15	92	16		St 135.00
Zimmertürschild	80.1180 BB78	48	262	15	92	16		St 135.00
Zimmertürschild	80.1180 RZ78	48	262	15	92	16		St 135.00
Zimmertürschild	80.1180 PZ78	48	262	15	92	16		St 135.00
Zimmertürschilder WC	80.1180 SK/OL78	48	262	15	92	16		Pr 380.00

Türgarnitur Serie Simplex

Bronze dunkel



Bezeichnung	Bestellnummer	H	I	H	Ø	Ø	□	CHF
Zimmertürgarnitur								
Zimmertürdrücker	80.1139.0	140		53		16	8	Pr 270.00
Drücker-Lochteil	80.1139.2	140		53		16	8	St 135.00
Zimmertürschild	80.1044 UG	40	230	4	80	16		St 110.00
Zimmertürschild	80.1044 BB78	40	230	4	80	16		St 110.00
Zimmertürschild	80.1044 RZ78	40	230	4	80	16		St 110.00
Zimmertürschild	80.1044 PZ78	40	230	4	80	16		St 110.00
Zimmertürschilder WC	80.1044 SK/OL78	40	230	4	80	16		Pr 330.00



Türgarnitur Serie Suculus

Bronze dunkel



Bezeichnung	Bestellnummer	H	I	H	Ø	Ø	□	CHF
Zimmertürgarnitur								
Zimmertürdrücker	80.1139R.0	140		53		16	8	Pr 340.00
Drücker-Lochteil	80.1139R.2	140		53		16	8	St 170.00
Zimmertürschild	80.1044 UG	40	230	4	80	16		St 110.00
Zimmertürschild	80.1044 BB78	40	230	4	80	16		St 110.00
Zimmertürschild	80.1044 RZ78	40	230	4	80	16		St 110.00
Zimmertürschild	80.1044 PZ78	40	230	4	80	16		St 110.00
Zimmertürschilder WC	80.1044 SK/OL78	40	230	4	80	16		Pr 330.00



Türgarnitur Serie Angulum

Bronze dunkel



Bezeichnung	Bestellnummer	H	I	H	Ø	Ø	□	CHF
Zimmertürgarnitur								
Zimmertürdrücker	80.1144.0	137		46		16	8	Pr 270.00
Drücker-Lochteil	80.1144.2	137		46		16	8	St 135.00
Zimmertürschild	80.1044 UG	40	230	4	80	16		St 110.00
Zimmertürschild	80.1044 BB78	40	230	4	80	16		St 110.00
Zimmertürschild	80.1044 RZ78	40	230	4	80	16		St 110.00
Zimmertürschild	80.1044 PZ78	40	230	4	80	16		St 110.00
Zimmertürschilder WC	80.1044 SK/OL78	40	230	4	80	16		Pr 330.00



**Türgarnitur Serie Spes**Bronze versilbert
mit Hochstellfeder

Bezeichnung	Bestellnummer	H	H	Ø	□	∞	CHF
Zimmertürgarnitur							
Zimmertürdrücker	83.1103.0	160	55	16	8		Pr 340.00
Drücker-Lochteil links	83.1103.2 Ls	160	55	16	8		St 170.00
Drücker-Lochteil rechts	83.1103.2 Rs	160	55	16	8		St 170.00
Drückerrosette	83.1538	54	12	16		38	St 70.00
Schlüsselrosette	83.1538 BB	54	11.5			38	St 70.00
Zylinderrosette	83.1538 RZ	54	11.5			38	St 70.00
Zylinderrosette	83.1538 PZ	54	11.5			38	St 70.00
WC-Rosetten	83.1538 SK/OL	54	43/18		7	38	Pr 284.00

**Türgarnitur Serie Quadrum**Bronze versilbert
mit Hochstellfeder

Bezeichnung	Bestellnummer	H	H	Ø	□	∞	CHF
Zimmertürgarnitur							
Zimmertürdrücker	83.1135.0	127	54	16	8		Pr 340.00
Drücker-Lochteil	83.1135.2	127	54	16	8		St 170.00
Drückerrosette	83.1538	54	12	16		38	St 70.00
Schlüsselrosette	83.1538 BB	54	11.5			38	St 70.00
Zylinderrosette	83.1538 RZ	54	11.5			38	St 70.00
Zylinderrosette	83.1538 PZ	54	11.5			38	St 70.00
WC-Rosetten	83.1538 SK/OL	54	43/18		7	38	Pr 284.00

**Türgarnitur Serie Latus**Bronze versilbert
mit Hochstellfeder

Bezeichnung	Bestellnummer	H	H	Ø	□	∞	CHF
Zimmertürgarnitur							
Zimmertürdrücker	83.1138.0	135	67	16	8		Pr 340.00
Drücker-Lochteil	83.1138.2	135	67	16	8		St 170.00
Drückerrosette	83.1538	54	12	16		38	St 70.00
Schlüsselrosette	83.1538 BB	54	11.5			38	St 70.00
Zylinderrosette	83.1538 RZ	54	11.5			38	St 70.00
Zylinderrosette	83.1538 PZ	54	11.5			38	St 70.00
WC-Rosetten	83.1538 SK/OL	54	43/18		7	38	Pr 284.00

**Türgarnitur Serie Simplex**Bronze versilbert
mit Hochstellfeder

Bezeichnung	Bestellnummer	H	H	Ø	□	∞	CHF
Zimmertürgarnitur							
Zimmertürdrücker	83.1139.0	140	53	16	8		Pr 340.00
Drücker-Lochteil	83.1139.2	140	53	16	8		St 170.00
Drückerrosette	83.1538	54	12	16		38	St 70.00
Schlüsselrosette	83.1538 BB	54	11.5			38	St 70.00
Zylinderrosette	83.1538 RZ	54	11.5			38	St 70.00
Zylinderrosette	83.1538 PZ	54	11.5			38	St 70.00
WC-Rosetten	83.1538 SK/OL	54	43/18		7	38	Pr 284.00

Türgarnitur Serie Suculus

Bronze versilbert
mit Hochstellfeder



Bezeichnung	Bestellnummer	H	H	Ø	□	⊙	CHF
Zimmertürgarnitur							
Zimmertürdrücker	83.1139R.0	140	53	16	8		Pr 420.00
Drücker-Lochteil	83.1139R.2	140	53	16	8		St 210.00
Drückerrosette	83.1538	54	12	16		38	St 70.00
Schlüsselrosette	83.1538 BB	54	11.5			38	St 70.00
Zylinderrosette	83.1538 RZ	54	11.5			38	St 70.00
Zylinderrosette	83.1538 PZ	54	11.5			38	St 70.00
WC-Rosetten	83.1538 SK/OL	54	43/18		7	38	Pr 284.00



Türgarnitur Serie Angulum

Bronze versilbert
mit Hochstellfeder



Bezeichnung	Bestellnummer	H	H	Ø	□	⊙	CHF
Zimmertürgarnitur							
Zimmertürdrücker	83.1144.0	137	46	16	8		Pr 340.00
Drücker-Lochteil	83.1144.2	137	46	16	8		St 170.00
Drückerrosette	83.1538	54	12	16		38	St 70.00
Schlüsselrosette	83.1538 BB	54	11.5			38	St 70.00
Zylinderrosette	83.1538 RZ	54	11.5			38	St 70.00
Zylinderrosette	83.1538 PZ	54	11.5			38	St 70.00
WC-Rosetten	83.1538 SK/OL	54	43/18		7	38	Pr 284.00

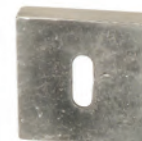

Türgarnitur Serie Tempus

Bronze versilbert
mit Hochstellfeder



Bezeichnung	Bestellnummer	H	H	Ø	□	⊙	CHF
Zimmertürgarnitur							
Zimmertürdrücker	83.1155.0	130	67	16	8		Pr 340.00
Drücker-Lochteil	83.1155.2	130	67	16	8		St 170.00
Drückerrosette	83.1548	55	12			38	St 70.00
Schlüsselrosette	83.1548 BB	55	11.5			38	St 70.00
Zylinderrosette	83.1548 PZ	55	11.5			38	St 70.00
Zylinderrosette	83.1548 RZ	55	11.5			38	St 70.00
WC-Rosetten	83.1548 SK/OL	55	41/18		7	38	Pr 284.00



Türgarnitur Serie Pax

Bronze versilbert
mit Hochstellfeder



Bezeichnung	Bestellnummer	H	H	Ø	□	⊙	CHF
Zimmertürgarnitur							
Zimmertürdrücker	83.1294.0	130	48	16	8		Pr 340.00
Drücker-Lochteil links	83.1294.2 Ls	130	48	16	8		St 170.00
Drücker-Lochteil rechts	83.1294.2 Rs	130	48	16	8		St 170.00
Drückerrosette	83.1548	55	12			38	St 70.00
Schlüsselrosette	83.1548 BB	55	11.5			38	St 70.00
Zylinderrosette	83.1548 PZ	55	11.5			38	St 70.00
Zylinderrosette	83.1548 RZ	55	11.5			38	St 70.00
WC-Rosetten	83.1548 SK/OL	55	41/18		7	38	Pr 284.00



**Türgarnitur Serie Spes**Bronze versilbert
mit Hochstellfeder

Bezeichnung	Bestellnummer	H	I	H	Ø	□	CHF
Zimmertürgarnitur							
Zimmertürdrücker	83.1103.0	160	55		16	8	Pr 340.00
Drücker-Lochteil links	83.1103.2 Ls	160	55		16	8	St 170.00
Drücker-Lochteil rechts	83.1103.2 Rs	160	55		16	8	St 170.00
Zimmertürschild	83.1180 UG	48	262	15	92	16	St 150.00
Zimmertürschild	83.1180 BB78	48	262	15	92	16	St 150.00
Zimmertürschild	83.1180 RZ78	48	262	15	92	16	St 150.00
Zimmertürschild	83.1180 PZ78	48	262	15	92	16	St 150.00
Zimmertürschilder WC	83.1180 SK/OL78	48	262	15	92	16	Pr 444.00

**Türgarnitur Serie Quadrum**

Bronze versilbert



Bezeichnung	Bestellnummer	H	I	H	Ø	□	CHF
Zimmertürgarnitur							
Zimmertürdrücker	83.1135.0	127	54		16	8	Pr 340.00
Drücker-Lochteil	83.1135.2	127	54		16	8	St 170.00
Zimmertürschild	83.1044 UG	40	230	4	80	16	St 140.00
Zimmertürschild	83.1044 BB78	40	230	4	80	16	St 140.00
Zimmertürschild	83.1044 RZ78	40	230	4	80	16	St 140.00
Zimmertürschild	83.1044 PZ78	40	230	4	80	16	St 140.00
Zimmertürschilder WC	83.1044 SK/OL78	40	230	4	80	16	Pr 424.00

**Türgarnitur Serie Latus**Bronze versilbert
mit Hochstellfeder

Bezeichnung	Bestellnummer	H	I	H	Ø	□	CHF
Zimmertürgarnitur							
Zimmertürdrücker	83.1138.0	135	67		16	8	Pr 340.00
Drücker-Lochteil	83.1138.2	135	67		16	8	St 170.00
Zimmertürschild	83.1180 UG	48	262	15	92	16	St 150.00
Zimmertürschild	83.1180 BB78	48	262	15	92	16	St 150.00
Zimmertürschild	83.1180 RZ78	48	262	15	92	16	St 150.00
Zimmertürschild	83.1180 PZ78	48	262	15	92	16	St 150.00
Zimmertürschilder WC	83.1180 SK/OL78	48	262	15	92	16	Pr 444.00

Türgarnitur Serie Simplex

Bronze versilbert



Bezeichnung	Bestellnummer	H	I	H	Ø	Ø	□	CHF
Zimmertürgarnitur								
Zimmertürdrücker	83.1139.0	140		53		16	8	Pr 340.00
Drücker-Lochteil	83.1139.2	140		53		16	8	St 170.00
Zimmertürschild	83.1044 UG	40	230	4	80	16		St 140.00
Zimmertürschild	83.1044 BB78	40	230	4	80	16		St 140.00
Zimmertürschild	83.1044 RZ78	40	230	4	80	16		St 140.00
Zimmertürschild	83.1044 PZ78	40	230	4	80	16		St 140.00
Zimmertürschilder WC	83.1044 SK/OL78	40	230	4	80	16		Pr 424.00



Türgarnitur Serie Suculus

Bronze versilbert



Bezeichnung	Bestellnummer	H	I	H	Ø	Ø	□	CHF
Zimmertürgarnitur								
Zimmertürdrücker	83.1139R.0	140		53		16	8	Pr 420.00
Drücker-Lochteil	83.1139R.2	140		53		16	8	St 210.00
Zimmertürschild	83.1044 UG	40	230	4	80	16		St 140.00
Zimmertürschild	83.1044 BB78	40	230	4	80	16		St 140.00
Zimmertürschild	83.1044 RZ78	40	230	4	80	16		St 140.00
Zimmertürschild	83.1044 PZ78	40	230	4	80	16		St 140.00
Zimmertürschilder WC	83.1044 SK/OL78	40	230	4	80	16		Pr 424.00



Türgarnitur Serie Angulum

Bronze versilbert



Bezeichnung	Bestellnummer	H	I	H	Ø	Ø	□	CHF
Zimmertürgarnitur								
Zimmertürdrücker	83.1144.0	137		46		16	8	Pr 340.00
Drücker-Lochteil	83.1144.2	137		46		16	8	St 170.00
Zimmertürschild	83.1044 UG	40	230	4	80	16		St 140.00
Zimmertürschild	83.1044 BB78	40	230	4	80	16		St 140.00
Zimmertürschild	83.1044 RZ78	40	230	4	80	16		St 140.00
Zimmertürschild	83.1044 PZ78	40	230	4	80	16		St 140.00
Zimmertürschilder WC	83.1044 SK/OL78	40	230	4	80	16		Pr 424.00



Eisen naturblank
 Eisen verzinkt-allpatiniert
 Eisen gerostet
 Bronze dunkel
 Bronze versilbert

Seite 2.02
 Seite 2.07
 Seite 2.10
 Seite 2.12
 Seite 2.12

Türknöpfe



Eisen naturblank
 Eisen verzinkt-allpatiniert
 Eisen gerostet

Seite 2.03
 Seite 2.08
 Seite 2.10

WC-Riegel



Eisen naturblank
 Eisen verzinkt-allpatiniert
 Eisen gerostet
 Bronze dunkel
 Bronze versilbert

Seite 2.04
 Seite 2.08
 Seite 2.11
 Seite 2.12
 Seite 2.12

Muschelgriffe



Eisen naturblank

Seite 2.04

Schiebetürbeschläge

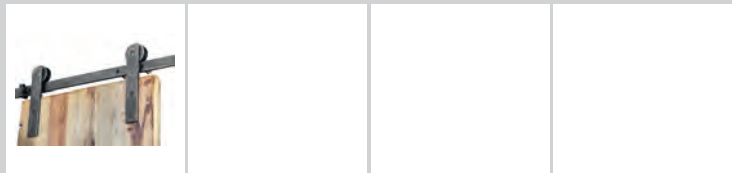

Eisen naturblank
 Eisen verzinkt-allpatiniert

Seite 2.05
 Seite 2.09

Stossgriffe



**Türknoopf**

Eisen naturblank



Bezeichnung	Bestellnummer	H	H	Ø	□	■	CHF
Türknoöpfe	13.211.0	58	63	18	8		Pr 200.60
Türknoopf-Lochteil	13.211.4	58	63	18	8		St 100.30
Türknoopf mit Wechselstift DUROQUICK	13.211.5 8x70	58	63	18	8x70		St 108.70
Türknoöpfe	13.211H.0	58	63	18	9		Pr 199.00
Türknoopf-Lochteil	13.211H.4	58	63	18	9	M12	St 99.50
Türknoopf mit Wechselstift DUROQUICK	13.211H.5 9x90	58	63	18	9x80		St 109.60

**Türknoopf fest**

Eisen naturblank

Bezeichnung	Bestellnummer	H	H	Ø	CHF
Türknoopf fest	13.211H/200 B	63	55	38	St 93.00

**Türknoopf**

Eisen naturblank

Bezeichnung	Bestellnummer	H	I	H	Ø	⊙	■	CHF
Türknoopf mit Rosette	13.214/214 B	102	58	48		74	M6	St 87.50
Türknoopf einzeln	13.214 M6	62	40	46			M6	St 60.00
Knopfrosette	13.214 R	102	58	2	6.3	74		St 27.50

**Türknoopf**

Eisen naturblank

Bezeichnung	Bestellnummer	H	H	Ø	⊙	■	CHF
Türknoopf mit Rosette	13.217/217 B	130	42		68	M6	St 262.50
Türknoopf einzeln	13.217 M6	59	41			M6	St 102.50
Knopfrosette	13.217 R	130	1	6.3	68		St 160.00

**Türknoopf**

Eisen naturblank



Bezeichnung	Bestellnummer	H	H	Ø	□	■	CHF
Türknoöpfe	13.219H.0	55	70	18	9		Pr 126.00
Türknoopf-Lochteil	13.219H.4	55	70	18	9	M12	St 63.00
Türknoopf mit Wechselstift DUROQUICK	13.219H.5 9x90	55	70	18	9x90		St 73.10

**Türknoopf fest**

Eisen naturblank

Bezeichnung	Bestellnummer	H	H	□	⊙	■	CHF
Türknoopf fest	13.219H/198 B	60	73	9	38	M12	St 112.50

**Türknoopf Serie Alv**

Eisen naturblank



Bezeichnung	Bestellnummer	H	H	Ø	□	■	CHF
Türknoöpfe	13.220.0	55	48	18	8		Pr 138.00
Türknoopf-Lochteil	13.220.4	55	48	18	8	M12	St 69.00
Türknoopf mit Wechselstift DUROQUICK	13.220.5 8x70	55	48	18	8x70		St 78.20

Türkнопf fest Serie Alv

Eisen naturblank

Bezeichnung	Bestellnummer	H	I	Ø	Ø	Ø	CHF
Türkнопf fest	13.220/205 B	55	51	8	38	M12	St 118.50



WC-Olive mit Notöffner

Eisen naturblank

für Schilder und Rosetten mit RZ-Lochung

Bezeichnung	Bestellnummer	H	I	H	Ø	Ø	CHF
WC-Olive mit Notöffner	13.395 WC-22						Pr 88.50
WC-Olive Lochteil	13.395 OL-22	40	26	32	22	7	St 69.00
WC-Notöffner mit Schlitz	13.395 S-22	26		11	22	7x72	St 19.50



WC-Olive mit Notöffner

Eisen naturblank

für Drückerrosetten mit 18mm-Lochung

Bezeichnung	Bestellnummer	H	I	H	Ø	Ø	CHF
WC-Olive mit Notöffner	13.396 WC-18						Pr 88.50
WC-Olive Lochteil	13.396 OL-18	40	26	32	18	7	St 69.00
WC-Notöffner mit Schlitz	13.396 S-18	26		11	18	7x72	St 19.50



WC-Olive mit Notöffner Serie Spedia

Eisen naturblank

für Schilder und Rosetten mit RZ-Lochung

Bezeichnung	Bestellnummer	H	I	H	Ø	Ø	CHF
WC-Olive mit Notöffner	13.397 WC-22						Pr 88.50
WC-Olive Lochteil	13.397 OL-22	42	26	26	22	7	St 69.00
WC-Notöffner mit Schlitz	13.395 S-22	26		11	22	7x72	St 19.50



WC-Olive mit Notöffner Serie Spedia

Eisen naturblank

für Drückerrosetten mit 18mm-Lochung

Bezeichnung	Bestellnummer	H	I	H	Ø	Ø	CHF
WC-Olive mit Notöffner	13.398 WC-18						Pr 88.50
WC-Olive Lochteil	13.398 OL-18	42	26	26	18	7	St 69.00
WC-Notöffner mit Schlitz	13.396 S-18	26		11	18	7x72	St 19.50



**Einlassgriff**

Eisen naturblank
Einlassmass 28 x 90 mm

Bezeichnung	Bestellnummer	H	I	H	H	∞	CHF
Einlassgriff	13.256/110 UG	40	110	2	9	115	St 47.00
Einlassgriff	13.256/110 BB	40	110	2	9	115	St 51.50

**Einlassgriff**

Eisen naturblank
Einlassmass 24 x 68 mm

Bezeichnung	Bestellnummer	H	I	H	H	CHF
Einlassgriff	13.257/120 UG	43	120	2	10	St 40.00
Einlassgriff	13.257/120 BB	43	120	2	10	St 46.00

**Einlassgriff**

Eisen naturblank
Einlassmass 24 x 68 mm

Bezeichnung	Bestellnummer	H	I	H	H	CHF
Einlassgriff	13.259/095 UG	43	95	2	7	St 32.50
Einlassgriff	13.259/095 BB	43	95	2	7	St 38.50
Einlassgriff	13.259/110 UG	43	110	2	10	St 38.50
Einlassgriff	13.259/110 BB	43	110	2	10	St 44.50
Einlassgriff	13.259/135 UG	43	135	2	10	St 42.50
Einlassgriff	13.259/135 BB	43	135	2	10	St 48.50

**Schiebetürgarnitur Serie Alv**

Eisen naturblank
Gewicht max. 80 kg / Dicke 35-45 mm / Laufschiene 1700mm: für Türbreite 800-950 mm / Laufschiene 2000mm: für Türbreite 950-1100mm

Bezeichnung	Bestellnummer	H	I	H	≠	CHF	
Schiebetürgarnitur	13.700				M10	Gt 540.00	
Lauf- und Befestigungs- profilsatz	13.700/1700	1700	30	43	8	M10	St 210.00
Lauf- und Befestigungs- profilsatz	13.700/2000	2000	30	43	8	M10	St 220.00
Führungzapfen komplett T-Guide Holz	650.080A TG						St 9.50

weitere technische Informationen im Online-Katalog auf www.zierbeschlaege.ch

Bügelgriff Serie Alv

Eisen naturblank

Bezeichnung	Bestellnummer	H	I	H	CHF
Bügelgriff	13.228	52	320	59	St 165.00

**Bügelgriff Serie Pollux**

Eisen naturblank

Bezeichnung	Bestellnummer	H	I	H	∞	CHF
Bügelgriff	13.230	75	385	65	310	St 165.00



**Zuziehgriff**

Eisen naturblank

Bezeichnung	Bestellnummer	H	I	H	mm	CHF
Zuziehgriff	13.224/140	70	140	68	M6	St 105.00

Türknoöpfe

Türknoopf

Eisen verzinkt-altpatiniert



Bezeichnung	Bestellnummer	H	H	Ø	□	mm	CHF
Türknoöpfe	15.211.0	58	63	18	8		Pr 230.60
Türknoopf-Lochteil	15.211.4	58	63	18	8		St 115.30
Türknoopf mit Wechselstift DUROQUICK	15.211.5 8x70	58	63	18	8x70		St 123.70
Türknoöpfe	15.211H.0	58	63	18	9		Pr 229.00
Türknoopf-Lochteil	15.211H.4	58	63	18	9	M12	St 114.50
Türknoopf mit Wechselstift DUROQUICK	15.211H.5 9x90	58	63	18	9x80		St 124.60



Türknoopf fest

Eisen verzinkt-altpatiniert

Bezeichnung	Bestellnummer	H	B	H	Ø	CHF
Türknoopf fest	15.211H/200 B	63	60	55	38	St 112.50



Türknoopf

Eisen verzinkt-altpatiniert



Bezeichnung	Bestellnummer	H	I	H	Ø	□	mm	CHF
Türknoöpfe	15.213.0	70	60	66	18	8		Pr 245.60
Türknoopf mit Wechselstift DUROQUICK	15.213.5 8x70	70	60	66	18	8x70		St 131.20
Türknoöpfe	15.213H.0	70	60	66	18	9		Pr 244.00
Türknoopf-Lochteil	15.213H.4	70	60	66	18	9	M12	St 122.00
Türknoopf mit Wechselstift DUROQUICK	15.213H.5 9x90	70	60	66	18	9x80		St 132.10



Türknoopf fest

Eisen verzinkt-altpatiniert

Bezeichnung	Bestellnummer	H	B	I	H	Ø	CHF
Türknoopf fest	15.213H/203 B	70	68	60	71	38	St 173.00



Türknoopf

Eisen verzinkt-altpatiniert



Bezeichnung	Bestellnummer	H	H	Ø	□	mm	CHF
Türknoöpfe	15.219H.0	55	70	18	9		Pr 156.00
Türknoopf-Lochteil	15.219H.4	55	70	18	9	M12	St 78.00
Türknoopf mit Wechselstift DUROQUICK	15.219H.5 9x90	55	70	18	9x90		St 88.10



Türknoopf fest

Eisen verzinkt-altpatiniert

Bezeichnung	Bestellnummer	H	B	H	□	Ø	mm	CHF
Türknoopf fest	15.219H/198 B	60	60	73	9	38	M12	St 133.00



2

**Türkнопf Serie Alv**

Eisen verzinkt-altpatiniert

Bezeichnung	Bestellnummer	H	I	Ø	□	▨	CHF
Türkнопfe	15.220.0	55	48	18	8		Pr 168.00
Türkнопf-Lochteil	15.220.4	55	48	18	8	M12	St 84.00
Türkнопf mit Wechselstift DUROQUICK	15.220.5 8x70	55	48	18	8x70		St 93.20

**Türkнопf fest Serie Alv**

Eisen verzinkt-altpatiniert

Bezeichnung	Bestellnummer	H	I	H	□	⊙	▨	CHF
Türkнопf fest	15.220/205 B	55	52	51	8	38	M12	St 139.00

**WC-Olive mit Notöffner**Eisen verzinkt-altpatiniert
für Schilder und Rosetten mit RZ-Lochung

Bezeichnung	Bestellnummer	H	I	H	Ø	□	CHF
WC-Olive mit Notöffner	15.395 WC-22						Pr 97.50
WC-Olive Lochteil	15.395 OL-22	40	26	32	22	7	St 73.50
WC-Notöffner mit Schlitz	15.395 S-22	26		11	22	7x72	St 24.00

**WC-Olive mit Notöffner**Eisen verzinkt-altpatiniert
für Drückerrosetten mit 18mm-Lochung

Bezeichnung	Bestellnummer	H	I	H	Ø	□	CHF
WC-Olive mit Notöffner	15.396 WC-18						Pr 97.50
WC-Olive Lochteil	15.396 OL-18	40	26	32	18	7	St 73.50
WC-Notöffner mit Schlitz	15.396 S-18	26		11	18	7x72	St 24.00

**WC-Olive mit Notöffner Serie Spedia**Eisen verzinkt-altpatiniert
für Schilder und Rosetten mit RZ-Lochung

Bezeichnung	Bestellnummer	H	I	H	Ø	□	CHF
WC-Olive mit Notöffner	15.397 WC-22						Pr 97.50
WC-Olive Lochteil	15.397 OL-22	42	26	26	22	7	St 73.50
WC-Notöffner mit Schlitz	15.395 S-22	26		11	22	7x72	St 24.00

**WC-Olive mit Notöffner Serie Spedia**Eisen verzinkt-altpatiniert
für Drückerrosetten mit 18mm-Lochung

Bezeichnung	Bestellnummer	H	I	H	Ø	□	CHF
WC-Olive mit Notöffner	15.398 WC-18						Pr 97.50
WC-Olive Lochteil	15.398 OL-18	42	26	26	18	7	St 73.50
WC-Notöffner mit Schlitz	15.396 S-18	26		11	18	7x72	St 24.00

**Einlassgriff**Eisen verzinkt-altpatiniert
Einlassmass 28 x 90 mm

Bezeichnung	Bestellnummer	H	I	H	H	⊙	CHF
Einlassgriff	15.256/110 UG	40	110	2	9	115	St 58.00
Einlassgriff	15.256/110 BB	40	110	2	9	115	St 62.50

Einlassgriff

Eisen verzinkt-altpatiniert
Einlassmass 24 x 68 mm

Bezeichnung	Bestellnummer	H	I	H	H	CHF
Einlassgriff	15.259/135 UG	43	135	2	8	St 54.50
Einlassgriff	15.259/135 BB	43	135	2	8	St 60.50

Bügelgriff Serie Alv

Eisen verzinkt-altpatiniert

Bezeichnung	Bestellnummer	H	I	H	CHF
Bügelgriff	15.228	52	320	59	St 195.00

Garagetorolive

Eisen verzinkt-altpatiniert

Bezeichnung	Bestellnummer	H	I	H	Ø	□	⊖	CHF
Garagetorolive	15.225	100	27	60	18	9		St 91.00
Rosette	15.225 R	70	60	6	18		38	St 58.00

Garagetorgriff

Eisen verzinkt-altpatiniert

Bezeichnung	Bestellnummer	H	I	H	⊖	▨	CHF
Garagetorgriff	15.226	220	50	50	170	M6	St 134.00



**Türknoopf**

Eisen gerostet

Bezeichnung	Bestellnummer	H	H	Ø	□	▨	CHF
Türknoöpfe	16.211.0	58	63	18	8		Pr 242.60
Türknoopf-Lochteil	16.211.4	58	63	18	8		St 121.30
Türknoopf mit Wechselstift DUROQUICK	16.211.5 8x70	58	63	18	8x70		St 129.70
Türknoöpfe	16.211H.0	58	63	18	9		Pr 241.00
Türknoopf-Lochteil	16.211H.4	58	63	18	9	M12	St 120.50
Türknoopf mit Wechselstift DUROQUICK	16.211H.5 9x90	58	63	18	9x80		St 130.60

**Türknoopf fest**

Eisen gerostet

Bezeichnung	Bestellnummer	H	H	Ø	CHF
Türknoopf fest	16.211H/200 B	63	55	38	St 120.00

**Türknoopf**

Eisen gerostet

Bezeichnung	Bestellnummer	H	H	Ø	□	▨	CHF
Türknoöpfe	16.219H.0	55	70	18	9		Pr 168.00
Türknoopf-Lochteil	16.219H.4	55	70	18	9	M12	St 84.00
Türknoopf mit Wechselstift DUROQUICK	16.219H.5 9x90	55	70	18	9x90		St 94.10

**Türknoopf fest**

Eisen gerostet

Bezeichnung	Bestellnummer	H	H	□	Ø	▨	CHF
Türknoopf fest	16.219H/198 B	60	73	9	38	M12	St 139.50

**Türknoopf Serie Alv**

Eisen gerostet

Bezeichnung	Bestellnummer	H	H	Ø	□	▨	CHF
Türknoöpfe	16.220.0	55	48	18	8		Pr 180.00
Türknoopf-Lochteil	16.220.4	55	48	18	8	M12	St 90.00
Türknoopf mit Wechselstift DUROQUICK	16.220.5 8x70	55	48	18	8x70		St 99.20

**Türknoopf fest Serie Alv**

Eisen gerostet

Bezeichnung	Bestellnummer	H	H	□	Ø	▨	CHF
Türknoopf fest	16.220/205 B	55	51	8	38	M12	St 145.50

**WC-Olive mit Notöffner**

Eisen gerostet

für Schilder und Rosetten mit RZ-Lochung

Bezeichnung	Bestellnummer	H	I	H	Ø	□	CHF
WC-Olive mit Notöffner	16.395 WC-22						Pr 100.50
WC-Olive Lochteil	16.395 OL-22	40	26	32	22	7	St 75.00
WC-Notöffner mit Schlitz	16.395 S-22	26		11	22	7x72	St 25.50

WC-Olive mit Notöffner

Eisen gerostet
für Drückerrosetten mit 18mm-Lochung

Bezeichnung	Bestellnummer	H	I	H	Ø	∇	CHF
WC-Olive mit Notöffner	16.396 WC-18						Pr 100.50
WC-Olive Lochteil	16.396 OL-18	40	26	32	18	7	St 75.00
WC-Notöffner mit Schlitz	16.396 S-18	26		11	18	7x72	St 25.50



WC-Olive mit Notöffner Serie Spedia

Eisen gerostet
für Schilder und Rosetten mit RZ-Lochung

Bezeichnung	Bestellnummer	H	I	H	Ø	∇	CHF
WC-Olive mit Notöffner	16.397 WC-22						Pr 100.50
WC-Olive Lochteil	16.397 OL-22	42	26	26	22	7	St 75.00
WC-Notöffner mit Schlitz	16.395 S-22	26		11	22	7x72	St 25.50



WC-Olive mit Notöffner Serie Spedia

Eisen gerostet
für Drückerrosetten mit 18mm-Lochung

Bezeichnung	Bestellnummer	H	I	H	Ø	∇	CHF
WC-Olive mit Notöffner	16.398 WC-18						Pr 100.50
WC-Olive Lochteil	16.398 OL-18	42	26	26	18	7	St 75.00
WC-Notöffner mit Schlitz	16.396 S-18	26		11	18	7x72	St 25.50



Einlassgriff

Eisen gerostet
Einlassmass 28 x 90 mm

Bezeichnung	Bestellnummer	H	I	H	H	∞	CHF
Einlassgriff	16.256/110 UG	40	110	2	9	115	St 62.50
Einlassgriff	16.256/110 BB	40	110	2	9	115	St 67.00



Einlassgriff

Eisen gerostet
Einlassmass 24 x 68 mm

Bezeichnung	Bestellnummer	H	I	H	H	CHF
Einlassgriff	16.259/135 UG	43	135	2	8	St 59.50
Einlassgriff	16.259/135 BB	43	135	2	8	St 65.50



**Türkнопf fest Serie Latus**

Bronze dunkel



Bezeichnung	Bestellnummer	H	H ₁	I	I _R	H	CHF
Türkнопf fest	80.1052H/1052H B	70	80	70	80	60	St 158.00

**Muschelgriff**

Bronze dunkel

Einlassmass 33 x 88 mm

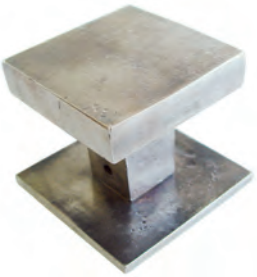

Bezeichnung	Bestellnummer	H	I	H	H	∞	CHF
Muschelgriff	80.1323 UG	43	145	3	15	115	St 85.00
Muschelgriff	80.1323 BB	43	145	3	15	115	St 85.00
Muschelgriff	80.1323 RZ	43	145	3	15	115	St 94.00
Muschelgriff	80.1323 PZ	43	145	3	15	115	St 94.00

**Türkнопf fest Serie Latus**

Bronze versilbert



Bezeichnung	Bestellnummer	H	H ₁	I	I _R	H	CHF
Türkнопf fest	83.1052H/1052H B	70	80	70	80	60	St 198.00

**Muschelgriff**

Bronze versilbert

Einlassmass 33 x 88 mm



Bezeichnung	Bestellnummer	H	I	H	H	∞	CHF
Muschelgriff	83.1323 UG	43	145	3	15	115	St 105.00
Muschelgriff	83.1323 BB	43	145	3	15	115	St 105.00
Muschelgriff	83.1323 RZ	43	145	3	15	115	St 114.00
Muschelgriff	83.1323 PZ	43	145	3	15	115	St 114.00

Eisen naturblank
Eisen verzinkt-alkalpatiniert
Eisen gerostet
Bronze dunkel
Bronze versilbert

Seite 3.02
Seite 3.19
Seite 3.29
Seite 3.39
Seite 3.43

Fenstergriffe



Eisen naturblank
Eisen verzinkt-alkalpatiniert
Eisen gerostet

Seite 3.06
Seite 3.22
Seite 3.32

abschliessbare Fenstergriffe

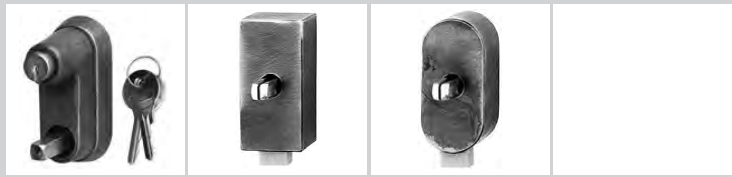

Eisen verzinkt-alkalpatiniert

Seite 3.22

Aussengriffe für Fenstertüren



Eisen naturblank
Eisen verzinkt-alkalpatiniert
Eisen gerostet
Bronze dunkel
Bronze versilbert

Seite 3.07
Seite 3.24
Seite 3.33
Seite 3.41
Seite 3.45

Hebeschiebegriffe

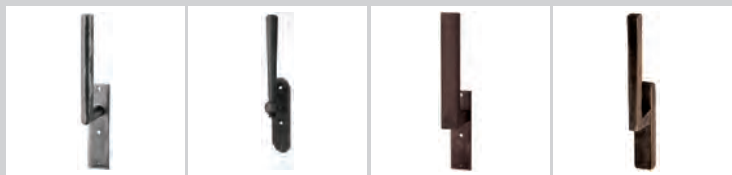

Eisen naturblank
Eisen verzinkt-alkalpatiniert
Eisen gerostet

Seite 3.10
Seite 3.28
Seite 3.37

Fensteroliven

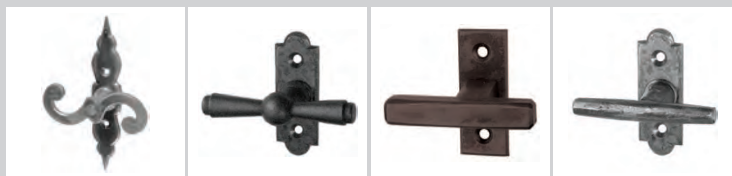

Eisen naturblank

Seite 3.12

Fensterkremonen



Eisen naturblank

Seite 3.14

Espagnoletten

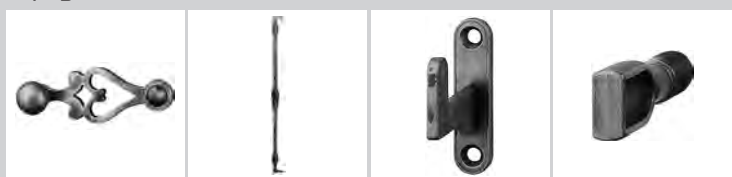

**Fenstergriff Serie Zupò**Eisen naturblank
Nocken 12 mm

Bezeichnung	Bestellnummer	\overline{R}_1	\overline{R}_2	\overline{G}	\overline{H}	\overline{Z}	\overline{O}	CHF
Fenstergriff	13.142/493 FR	30	70	120	63	7x38	43	St 167.00
Fenstertürgriff	13.142/493 IR	30	70	120	63	7x90	43	St 179.00

**Fenstergriff Serie Zupò**Eisen naturblank
Nocken 10 mm

Bezeichnung	Bestellnummer	\overline{R}_1	\overline{R}_2	\overline{G}	\overline{H}	\overline{Z}	\overline{O}	CHF
Fenstergriff	13.142/496 FR	33	67	120	75	7x38	43	St 167.00
Fenstertürgriff	13.142/496 IR	33	67	120	75	7x90	43	St 179.00

**Fenstergriff Serie Bernina**Eisen naturblank
Nocken 12 mm

Bezeichnung	Bestellnummer	\overline{R}_1	\overline{R}_2	\overline{G}	\overline{H}	\overline{Z}	\overline{O}	CHF
Fenstergriff	13.143/493 FR	30	70	120	63	7x38	43	St 166.50
Fenstertürgriff	13.143/493 IR	30	70	120	63	7x90	43	St 178.50

**Fenstergriff Serie Bernina**Eisen naturblank
Nocken 10 mm

Bezeichnung	Bestellnummer	\overline{R}_1	\overline{R}_2	\overline{G}	\overline{H}	\overline{Z}	\overline{O}	CHF
Fenstergriff	13.143/496 FR	33	67	120	74	7x38	43	St 166.50
Fenstertürgriff	13.143/496 IR	33	67	120	74	7x90	43	St 178.50

Fenstergriff Serie AlvEisen naturblank
Nocken 12 mm

Bezeichnung	Bestellnummer							CHF
Fenstergriff	13.144/493 FR	30	70	120	53	7x38	43	St 166.00
Fenstertürgriff	13.144/493 IR	30	70	120	53	7x90	43	St 178.00

**Fenstergriff Serie Alv**Eisen naturblank
Nocken 10 mm

Bezeichnung	Bestellnummer							CHF
Fenstergriff	13.144/494 FR	33	67	120	64	7x38	43	St 166.00
Fenstertürgriff	13.144/494 IR	33	67	120	64	7x90	43	St 178.00

**Fenstergriff Serie Zinal**Eisen naturblank
Nocken 12 mm

Bezeichnung	Bestellnummer							CHF
Fenstergriff	13.145/493 FR	30	70	120	56	7x38	43	St 162.00
Fenstertürgriff	13.145/493 IR	30	70	120	56	7x90	43	St 174.00

**Fenstergriff Serie Zinal**Eisen naturblank
Nocken 10 mm

Bezeichnung	Bestellnummer							CHF
Fenstergriff	13.145/494 FR	33	67	120	67	7x38	43	St 162.00
Fenstertürgriff	13.145/494 IR	33	67	120	67	7x90	43	St 174.00



**Fenstergriff Serie Spedia**Eisen naturblank
Nocken 12 mmHAGER
MULTITAC

Bezeichnung	Bestellnummer	$\overline{R_1}$	$\overline{R_2}$	\overline{G}	\overline{H}	\overline{Z}	\overline{D}	CHF
Fenstergriff	13.146/493 FR	30	70	122	58	7x38	43	St 165.00
Fenstertürgriff	13.146/493 IR	30	70	122	58	7x90	43	St 177.00

**Fenstergriff Serie Besso**Eisen naturblank
Nocken 12 mmHAGER
MULTITAC

Bezeichnung	Bestellnummer	$\overline{R_1}$	$\overline{R_2}$	\overline{G}	\overline{H}	\overline{Z}	\overline{D}	CHF
Fenstergriff	13.148/493 FR	30	70	120	61	7x38	43	St 157.00
Fenstertürgriff	13.148/493 IR	30	70	120	61	7x90	43	St 169.00

**Fenstergriff Serie Ochs**Eisen naturblank
Nocken 12 mmHAGER
MULTITAC

Bezeichnung	Bestellnummer	$\overline{R_1}$	$\overline{R_2}$	\overline{G}	\overline{H}	\overline{Z}	\overline{D}	CHF
Fenstergriff	13.168/499 FR	30	81	110	65	7x38	43	St 181.00
Fenstertürgriff	13.168/499 IR	30	81	110	65	7x90	43	St 193.00

**Fenstergriff Serie Castor**Eisen naturblank
Nocken 12 mmHAGER
MULTITAC

Bezeichnung	Bestellnummer	$\overline{R_1}$	$\overline{R_2}$	\overline{G}	\overline{H}	\overline{Z}	\overline{D}	CHF
Fenstergriff	13.170/499 FR	30	81	120	65	7x38	43	St 172.50
Fenstertürgriff	13.170/499 IR	30	81	120	65	7x90	43	St 184.50

Fenstergriff Serie NordendEisen naturblank
Nocken 12 mm

Bezeichnung	Bestellnummer							CHF
Fenstergriff	13.181/499 FR	30	81	140	78	7x38	43	St 195.00
Fenstertürgriff	13.181/499 IR	30	81	140	78	7x90	43	St 207.00

**Fenstergriff Serie Dom**Eisen naturblank
Nocken 12 mm

Bezeichnung	Bestellnummer							CHF
Fenstergriff	13.184/495 FR	30	80	125	65	7x38	43	St 149.00
Fenstertürgriff	13.184/495 IR	30	80	125	65	7x90	43	St 161.00

**Fenstergriff Serie Parrot**Eisen naturblank
Nocken 10 mm

Bezeichnung	Bestellnummer							CHF
Fenstergriff	13.185/496 FR	33	67	115	64	7x38	43	St 153.00
Fenstertürgriff	13.185/496 IR	33	67	115	64	7x90	43	St 165.00

**Fenstergriff Serie Pollux**Eisen naturblank
Nocken 12 mm

Bezeichnung	Bestellnummer							CHF
Fenstergriff	13.186/495 FR	30	80	120	60	7x38	43	St 162.50
Fenstertürgriff	13.186/495 IR	30	80	120	60	7x90	43	St 174.50



**Fenstergriff Serie Combin**Eisen naturblank
Nocken 10 mm

Bezeichnung	Bestellnummer							CHF
Fenstergriff	13.188/496 FR	33	67	130	77	7x38	43	St 153.00
Fenstertürgriff	13.188/496 IR	33	67	130	77	7x90	43	St 165.00

**Fenstergriff Serie Combin**Eisen naturblank
Nocken 12 mm

Bezeichnung	Bestellnummer							CHF
Fenstergriff	13.188/498 FR	30	70	130	59	7x38	43	St 153.00
Fenstertürgriff	13.188/498 IR	30	70	130	59	7x90	43	St 165.00

HAGER
MULTITAC**Oblichtöffner**Eisen naturblank
Nocken 12 mm

Bezeichnung	Bestellnummer							CHF
Oblichtöffner	13.192/493 FR	30	70	80	31	7x38	43	St 142.00

HAGER
MULTITAC**Rosette mit Druckknopf**Eisen naturblank
Nocken 10 mm

Bezeichnung	Bestellnummer						CHF
Rosette mit Druckknopf	13.494 SV	33	67	17	7x38	43	St 135.50

**Rosette mit Druckknopf**Eisen naturblank
Nocken 10 mm

Bezeichnung	Bestellnummer						CHF
Rosette mit Druckknopf	13.496 SV	33	67	17	7x38	43	St 135.50



**Rosette mit Zylinder**

Eisen naturblank

Bezeichnung	Bestellnummer						CHF
Rosette mit Zylinder	13.709-7/16	33	75	44	7x38	43	St 175.00
Rosette mit Zylinder	13.709-8/16	33	75	44	7x38	43	St 140.00

Hebeschiebetürgriff Serie Zupò





Eisen naturblank

Bezeichnung	Bestellnummer							CHF
Hebeschiebetürgriff	13.142HS/147K	40	160	220	63	10x95	80	St 312.50

Bei Bestellung Schraubengrösse angeben: M5x80 / M5x100 / M6x080 / M6x100

**Hebeschiebetürgriff Serie Alv**

Eisen naturblank

Bezeichnung	Bestellnummer							CHF
Hebeschiebetürgriff	13.144HS/147K	40	160	210	58	10x95	80	St 317.50

Bei Bestellung Schraubengrösse angeben: M5x80 / M5x100 / M6x080 / M6x100



**Hebeschiebetürgriff Serie Spedia**

Eisen naturblank

Bezeichnung	Bestellnummer							CHF
Hebeschiebetürgriff	13.146HS/147K	40	160	210	60	10x95	80	St 302.50

Bei Bestellung Schraubengrösse angeben: M5x80 / M5x100 / M6x080 / M6x100

**Hebeschiebetürgriff Serie Besso**

Eisen naturblank

Bezeichnung	Bestellnummer							CHF
Hebeschiebetürgriff	13.148HS/147K	40	160	223	60	10x95	80	St 312.50

Bei Bestellung Schraubengrösse angeben: M5x80 / M5x100 / M6x080 / M6x100

Hebeschiebetürgriff Serie Dom

Eisen naturblank

Bezeichnung	Bestellnummer	$\overline{R_1}$	\overline{R}	$\overline{T_G}$	\overline{H}	\overline{B}	\overline{D}	\overline{L}	CHF
Hebeschiebetürgriff	13.184HS/187K	40	170	225	76	10x95	80	St	314.00

Bei Bestellung Schraubengrösse angeben: M5x80 / M5x100 / M6x080 / M6x100



3

Hebeschiebetürgriff Serie Pollux

Eisen naturblank

Bezeichnung	Bestellnummer	$\overline{R_1}$	\overline{R}	$\overline{T_G}$	\overline{H}	\overline{B}	\overline{D}	\overline{L}	CHF
Hebeschiebetürgriff	13.186HS/187K	40	170	210	85	10x95	80	St	299.00

Bei Bestellung Schraubengrösse angeben: M5x80 / M5x100 / M6x080 / M6x100



**Hebeschiebetürgriff Serie Combin**

Eisen naturblank

Bezeichnung	Bestellnummer	\overline{R}_1	\overline{R}_2	\overline{G}	\overline{H}	\overline{D}	\overline{S}	CHF
Hebeschiebetürgriff	13.188HS/191K	40	160	225	73	10x95	80	St 337.00

Bei Bestellung Schraubengrösse angeben: M5x80 / M5x100 / M6x080 / M6x100

Fensterolive Serie DomEisen naturblank
ohne Nocken

Bezeichnung	Bestellnummer	\overline{R}_1	\overline{R}_2	\overline{G}	\overline{H}	\overline{D}	\overline{S}	CHF
Fensterolive	13.444/495L F	25	75	100	52	7x38	43	St 88.00
Fensterolive mit Rastung	13.444/495 FR	30	80	100	52	7x38	43	St 130.00

Fensterolive Serie AlvEisen naturblank
ohne Nocken

Bezeichnung	Bestellnummer	\overline{R}_1	\overline{R}_2	\overline{G}	\overline{H}	\overline{D}	\overline{S}	CHF
Fensterolive	13.446/493L F	25	66	84	45	7x38	43	St 95.00
Fensterolive mit Rastung	13.446/493 FR	30	70	84	45	7x38	43	St 137.00







Fensterolive Serie ZupòEisen naturblank
ohne Nocken

Bezeichnung	Bestellnummer	\overline{R}_1	\overline{R}_2	\overline{G}	\overline{H}	\overline{D}	\overline{S}	CHF
Fensterolive	13.447/493L F	25	66	80	46	7x38	43	St 79.50
Fensterolive mit Rastung	13.447/493 FR	30	70	80	46	7x38	43	St 137.50







Fensterolive Serie SpediaEisen naturblank
ohne Nocken

Bezeichnung	Bestellnummer	\overline{R}_1	\overline{R}_2	\overline{G}	\overline{H}	\overline{D}	\overline{S}	CHF
Fensterolive	13.448/493L F	25	66	70	46	7x38	43	St 79.50
Fensterolive mit Rastung	13.448/493 FR	30	70	70	46	7x38	43	St 137.50

Fensterolive Serie PolluxEisen naturblank
ohne Nocken

Bezeichnung	Bestellnummer							CHF
Fensterolive	13.449/492 F	31	94	85	46	7x38	43	St 79.50
Fensterolive mit Rastung	13.449/492 FR	31	94	85	46	7x38	43	St 140.50







**Fensterolive Serie Pollux**Eisen naturblank
ohne Nocken

Bezeichnung	Bestellnummer							CHF
Fensterolive	13.449/495L F	25	75	85	46	7x38	43	St 79.50
Fensterolive mit Rastung	13.449/495 FR	30	80	85	46	7x38	43	St 137.50







**Fensterolive**Eisen naturblank
ohne Nocken

Bezeichnung	Bestellnummer							CHF
Fensterolive	13.450 F	26	92	95	50	7x38	43	St 79.50







**Fensterolive Serie Amiante**Eisen naturblank
ohne Nocken

Bezeichnung	Bestellnummer							CHF
Fensterolive	13.451 F	25	130	85	47	7x38	43	St 79.50

**Fensterolive Serie Amiante**Eisen naturblank
ohne Nocken

Bezeichnung	Bestellnummer							CHF
Fensterolive	13.452 F	20	92	58	35	7x38	43	St 79.50

**Fensterolive Serie Bellavista**Eisen naturblank
ohne Nocken

Bezeichnung	Bestellnummer							CHF
Fensterolive	13.454/499L F	25	77	78	43	7x38	43	St 79.50
Fensterolive mit Rastung	13.454/499 FR	30	80	87	47	7x38	43	St 144.00



**Fensterolive**Eisen naturblank
ohne Nocken

Bezeichnung	Bestellnummer							CHF
Fensterolive	13.456/495L F	25	75	87	47	7x38	43	St 88.00
Fensterolive mit Rastung	13.456/495 FR	30	80	87	47	7x38	43	St 130.00

**Fensterolive Serie Pollux**Eisen naturblank
ohne Nocken

Bezeichnung	Bestellnummer							CHF
Fensterolive	13.457/495L F	25	75	76	44	7x38	43	St 79.50
Fensterolive mit Rastung	13.457/495 FR	30	80	76	44	7x38	43	St 137.50

**Fensterolive Serie Spedia**Eisen naturblank
ohne Nocken

Bezeichnung	Bestellnummer							CHF
Fensterolive	13.459/493L F	25	66	75	54	7x38	43	St 79.50
Fensterolive mit Rastung	13.459/493 FR	30	70	75	54	7x38	43	St 137.50

**Fensterolive Serie Combin**Eisen naturblank
ohne Nocken

Bezeichnung	Bestellnummer							CHF
Fensterolive	13.488/498L F	25	76	106	54	7x38	43	St 96.00
Fensterolive mit Rastung	13.488/498 FR	30	70	106	54	7x38	43	St 138.00

**Kremone Serie Dom**Eisen naturblank
mit Mechanismus / ohne Zubehör

Bezeichnung	Bestellnummer						CHF
Kremone	13.444/763 CR	42	147	91	71	28	St 144.00

Kombination mit anderen Oliven möglich

**Scheinkremone Serie Dom**Eisen naturblank
Nocken 10 mm / mit Mechanismus / ohne Zubehör

Bezeichnung	Bestellnummer							CHF
Scheinkremone	13.444/763 DK-FR	42	147	91	71	7x38	28	St 136.00

Kombination mit anderen Oliven möglich

Endführung

Eisen naturblank

Bezeichnung	Bestellnummer	H	I	H	∞	CHF
Endführung	13.763 EF	42	61	17	28	St 14.50

**Endkloben**

Eisen naturblank

Bezeichnung	Bestellnummer	H	I	H	∞	CHF
Endkloben	13.763 EK	42	32	18	28	St 15.00

**Unterlage zu Endkloben**

Eisen naturblank

Bezeichnung	Bestellnummer	H	I	∞	≠	CHF
Unterlage zu Endkloben	13.763 EU 06 mm	44	34	27	6	St 15.00
Unterlage zu Endkloben	13.763 EU 10 mm	44	34	27	10	St 16.00
Unterlage zu Endkloben	13.763 EU 28 mm	44	34	27	28	St 29.00
Unterlage zu Endkloben	13.763 EU 33 mm	44	34	27	33	St 29.00

**Mittelführung**

Eisen naturblank

Bezeichnung	Bestellnummer	H	I	H	∞	CHF
Mittelführung	13.763 MF	42	82	17	28	St 17.00

**Halbrundstange**

Eisen naturblank

Bezeichnung	Bestellnummer	H	I	H	CHF
Halbrundstange	13.763 ST 1300 mm	16	1300	7.5	St 60.00



**Ruder mit Knopf**

Eisen naturblank / Knopf Eisen naturblank (K13) - Knopf Messing poliert (K20) - Knopf Messing matt vernickelt (K23)

Bezeichnung	Bestellnummer	H	I	H	CHF
Ruder mit Knopf	13.717 K13	136	32	38	St 68.50
Ruder mit Knopf	13.717 K20	136	32	32	St 68.50
Ruder mit Knopf	13.717 K23	136	32	32	St 68.50

**Ruder mit Knopf**

Eisen naturblank / Knopf Eisen naturblank (K13) - Knopf Messing poliert (K20) - Knopf Messing matt vernickelt (K23)

Bezeichnung	Bestellnummer	H	I	H	CHF
Ruder mit Knopf	13.718 K13	125	40	38	St 68.50
Ruder mit Knopf	13.718 K20	125	40	32	St 68.50
Ruder mit Knopf	13.718 K23	125	40	32	St 68.50

**Ruder mit Knopf**

Eisen naturblank / Knopf Eisen naturblank (K13) - Knopf Messing poliert (K20) - Knopf Messing matt vernickelt (K23)

Bezeichnung	Bestellnummer	H	I	H	CHF
Ruder mit Knopf	13.720 K13	125	30	38	St 68.50
Ruder mit Knopf	13.720 K20	125	30	32	St 68.50
Ruder mit Knopf	13.720 K23	125	30	32	St 68.50

**Ruder mit Knopf**

Eisen naturblank / Knopf Eisen naturblank (K13) - Knopf Messing poliert (K20) - Knopf Messing matt vernickelt (K23)

Bezeichnung	Bestellnummer	H	I	H	CHF
Ruder mit Knopf	13.722 K13	133	50	38	St 68.50
Ruder mit Knopf	13.722 K20	133	50	32	St 68.50
Ruder mit Knopf	13.722 K23	133	50	32	St 68.50

**Ruder mit Knopf**

Eisen naturblank / Knopf Eisen naturblank (K13) - Knopf Messing poliert (K20) - Knopf Messing matt vernickelt (K23)

Bezeichnung	Bestellnummer	H	I	H	CHF
Ruder mit Knopf	13.723 K13	132	78	38	St 68.50
Ruder mit Knopf	13.723 K20	132	60	32	St 68.50
Ruder mit Knopf	13.723 K23	132	60	32	St 68.50

**Ruder mit Knopf**

Eisen naturblank / Knopf Eisen naturblank (K13) - Knopf Messing poliert (K20) - Knopf Messing matt vernickelt (K23)

Bezeichnung	Bestellnummer	H	I	H	CHF
Ruder mit Knopf	13.724 K13	133	30	37	St 68.50
Ruder mit Knopf	13.724 K20	133	30	31	St 68.50
Ruder mit Knopf	13.724 K23	133	30	31	St 68.50

**Ruder mit Knopf**

Eisen naturblank / Knopf Eisen naturblank (K13) - Knopf Messing poliert (K20) - Knopf Messing matt vernickelt (K23)

Bezeichnung	Bestellnummer	H	I	H	CHF
Ruder mit Knopf	13.726 K13	120	37	38	St 68.50
Ruder mit Knopf	13.726 K20	120	37	32	St 68.50
Ruder mit Knopf	13.726 K23	120	37	32	St 68.50

EspanoletteEisen naturblank
mit geraden Schlaufen (D1)

Bezeichnung	Bestellnummer	H	R	I	R	H	Ø	CHF
Espanolette zum Verschrauben	13.480/0900 D1 M6			900			15	St 251.50
Espanolette zum Verschrauben	13.480/1400 D1 M6			1400			15	St 261.50
Espanolette zum Verschrauben	13.480/2000 D1 M6			2000			15	St 289.50
Espanolette zum Verschrauben	13.480/2500 D1 M6			2500			15	St 299.50
Espanolette zum Verstimfen	13.480/0900 D1 9x31mm			900			15	St 278.50
Espanolette zum Verstimfen	13.480/1400 D1 9x31mm			1400			15	St 288.50
Espanolette zum Verstimfen	13.480/2000 D1 9x31mm			2000			15	St 325.50
Espanolette zum Verstimfen	13.480/2500 D1 9x31mm			2500			15	St 335.50
Ruderkloben gerade	13.480 RK/0 mm		14		85	28		St 36.00
Ruderkloben gerade	13.480 RK/18mm		14		85	46		St 36.00
Ruderkloben gekröpft links	13.480 RK GK/0 mm Ls	42	14		85	32		St 36.00
Ruderkloben gekröpft rechts	13.480 RK GK/0 mm Rs	42	14		85	32		St 36.00

nicht mit anderen Ruder kombinierbar / detailliertes Bestellformular auf www.zierbeschlaege.ch**Stange mit Schlaufen**Eisen naturblank
mit geraden Schlaufen (D1)

Bezeichnung	Bestellnummer	I	Ø	H	Ø	CHF
Stange mit Schlaufen zum Verschrauben	13.760/0900 D1 M6	900	15	12	3xM6	St 172.50
Stange mit Schlaufen zum Verschrauben	13.760/1400 D1 M6	1400	15	12	3xM6	St 182.50
Stange mit Schlaufen zum Verschrauben	13.760/2000 D1 M6	2000	15	12	4xM6	St 210.50
Stange mit Schlaufen zum Verschrauben	13.760/2500 D1 M6	2500	15	12	4xM6	St 220.50
Stange mit Schlaufen zum Verstimfen	13.760/0900 D1 9x31mm	900	15	39	12	St 199.50
Stange mit Schlaufen zum Verstimfen	13.760/1400 D1 9x31mm	1400	15	39	12	St 209.50
Stange mit Schlaufen zum Verstimfen	13.760/2000 D1 9x31mm	2000	15	39	12	St 246.50
Stange mit Schlaufen zum Verstimfen	13.760/2500 D1 9x31mm	2500	15	39	12	St 256.50

Detailliertes Bestellformular auf www.zierbeschlaege.ch



Stange mit Schlaufen

Eisen naturblank
mit bombierten Schlaufen (D2)

Bezeichnung	Bestellnummer	I	i	H	∅	mm	CHF
Stange mit Schlaufen zum Verschrauben	13.760/0900 D2 M6	900	15		12	4xM6	St 184.50
Stange mit Schlaufen zum Verschrauben	13.760/1400 D2 M6	1400	15		12	4xM6	St 194.50
Stange mit Schlaufen zum Verschrauben	13.760/2000 D2 M6	2000	15		12	5xM6	St 225.50
Stange mit Schlaufen zum Verschrauben	13.760/2500 D2 M6	2500	15		12	5xM6	St 235.50
Stange mit Schlaufen zum Verstiften	13.760/0900 D2 9x31mm	900	15	39	12		St 220.50
Stange mit Schlaufen zum Verstiften	13.760/1400 D2 9x31mm	1400	15	39	12		St 230.50
Stange mit Schlaufen zum Verstiften	13.760/2000 D2 9x31mm	2000	15	39	12		St 270.50
Stange mit Schlaufen zum Verstiften	13.760/2500 D2 9x31mm	2500	15	39	12		St 280.50

Detailliertes Bestellformular auf www.zierbeschlaege.ch

Stange mit Schlaufen

Eisen naturblank
mit verzierten Schlaufen (D3)

Bezeichnung	Bestellnummer	I	i	H	∅	mm	CHF
Stange mit Schlaufen zum Verschrauben	13.760/0900 D3 M6	900	15		12	3xM6	St 214.50
Stange mit Schlaufen zum Verschrauben	13.760/1400 D3 M6	1400	15		12	3xM6	St 224.50
Stange mit Schlaufen zum Verschrauben	13.760/2000 D3 M6	2000	15		12	4xM6	St 264.50
Stange mit Schlaufen zum Verschrauben	13.760/2500 D3 M6	2500	15		12	4xM6	St 274.50
Stange mit Schlaufen zum Verstiften	13.760/0900 D3 9x31mm	900	15	39	12		St 241.50
Stange mit Schlaufen zum Verstiften	13.760/1400 D3 9x31mm	1400	15	39	12		St 251.50
Stange mit Schlaufen zum Verstiften	13.760/2000 D3 9x31mm	2000	15	39	12		St 300.50
Stange mit Schlaufen zum Verstiften	13.760/2500 D3 9x31mm	2500	15	39	12		St 310.50

Detailliertes Bestellformular auf www.zierbeschlaege.ch

Endkloben mit Platte rund

Eisen naturblank
für Überschlag 18mm / verstellbar +/- 2mm

Bezeichnung	Bestellnummer	H	H	∅	∞	≠	▨	CHF
Endkloben mit Platte rund	13.760 EK R	39	3	36	22	18	M6	St 23.00

**Einschraub-Endkloben**

Eisen naturblank
für Überschlag 16-24mm

Bezeichnung	Bestellnummer	H	▨	CHF
Einschraub-Endkloben	13.760 EK S	62	M16	St 15.00

**Endkloben zum Einschlagen**

Eisen naturblank

Bezeichnung	Bestellnummer	H	I	H	≠	CHF
Endkloben zum Einschlagen	13.760 EKH E	6	25	45	6	St 21.50

**Endkloben mit Platte rechteckig**

Eisen naturblank

Bezeichnung	Bestellnummer	LR	TR	H	H	∞	≠	CHF
Endkloben mit Platte rechteckig	13.760 EKH Q	30	22	39	3	16	18	St 25.00

**Ruderkloben gekröpft**

Eisen naturblank

Bezeichnung	Bestellnummer	H	LR	TR	H	H	∞	CHF
Ruderkloben gekröpft links	13.760 RK GK/0 mm Ls	48	17	70	47	4	53	St 27.00
Ruderkloben gekröpft rechts	13.760 RK GK/0 mm Rs	48	17	70	47	4	53	St 27.00

**Ruderkloben gerade abschliessbar**

Eisen naturblank
mit integriertem Schlüssel- und Zylinderdepot

Bezeichnung	Bestellnummer	LR	TR	H	H	∞	≠	CHF
Ruderkloben gerade abschliessbar	13.760 RK S/0 mm	17	70	50	4	53	0	St 120.00

**Ruderkloben gerade**

Eisen naturblank

Bezeichnung	Bestellnummer	LR	TR	H	H	∞	≠	CHF
Ruderkloben gerade	13.760 RK/0 mm	17	70	46	4	53	0	St 18.00
Ruderkloben gerade	13.760 RK/18 mm	17	70	64	4	53	18	St 18.00



**Ruderklöben gekröpft**Eisen naturblank
handgeschmiedet

Bezeichnung	Bestellnummer	H	H _R	H _R	H	∅	≠	CHF
Ruderklöben gekröpft links	13.760 RKH GK/0 mm Ls	42	14	85	47	58	0	St 36.00
Ruderklöben gekröpft rechts	13.760 RKH GK/0 mm Rs	42	14	85	47	58	0	St 36.00

**Ruderklöben gerade**Eisen naturblank
handgeschmiedet

Bezeichnung	Bestellnummer	H _R	H _R	H	∅	≠	CHF
Ruderklöben gerade	13.760 RKH/0 mm	14	85	46	58	0	St 36.00
Ruderklöben gerade	13.760 RKH/18mm	14	85	64	58	18	St 36.00

**Distanzplatte**Eisen naturblank
zu Ruderklöben / ermöglicht Anpassung an Überschlag +/- 2mm

Bezeichnung	Bestellnummer	H _R	H _R	∅	≠	CHF
Distanzplatte	13.760 UP	17	70	53	2	St 6.00

Fenstergriff Serie ZupòEisen verzinkt-altpatiniert
Nocken 12 mm

Bezeichnung	Bestellnummer	FR	IR	AR	H	Ø	Ø	CHF
Fenstergriff	15.142/493 FR	30	70	120	63	7x38	43	St 187.50
Fenstertürgriff	15.142/493 IR	30	70	120	63	7x90	43	St 199.50
Aussengriff	15.142/493 AR	30	70	120	63	7	43	St 199.50

**Fenstergriff Serie Zupò**Eisen verzinkt-altpatiniert
Nocken 10 mm

Bezeichnung	Bestellnummer	FR	IR	AR	H	Ø	Ø	CHF
Fenstergriff	15.142/496 FR	33	67	120	75	7x38	43	St 187.50
Fenstertürgriff	15.142/496 IR	33	67	120	75	7x90	43	St 199.50
Aussengriff	15.142/496 AR	33	67	120	75	7	43	St 199.50

**Fenstergriff Serie Alv**Eisen verzinkt-altpatiniert
Nocken 12 mm

Bezeichnung	Bestellnummer	FR	IR	AR	H	Ø	Ø	CHF
Fenstergriff	15.144/493 FR	30	70	120	53	7x38	43	St 186.50
Fenstertürgriff	15.144/493 IR	30	70	120	53	7x90	43	St 198.50
Aussengriff	15.144/493 AR	30	70	120	53	7	43	St 198.50

**Fenstergriff Serie Alv**Eisen verzinkt-altpatiniert
Nocken 10 mm

Bezeichnung	Bestellnummer	FR	IR	AR	H	Ø	Ø	CHF
Fenstergriff	15.144/494 FR	33	67	120	64	7x38	43	St 186.50
Fenstertürgriff	15.144/494 IR	33	67	120	64	7x90	43	St 198.50
Aussengriff	15.144/494 AR	33	67	120	64	7	43	St 198.50



**Fenstergriff Serie Zinal**Eisen verzinkt-altpatiniert
Nocken 12 mmHAGER
MULTITAC

Bezeichnung	Bestellnummer	\overline{R}_1	\overline{R}_2	\overline{L}_G	\overline{H}	\overline{B}	\overline{D}	CHF
Fenstergriff	15.145/493 FR	30	70	120	56	7x38	43	St 182.50
Fenstertürgriff	15.145/493 IR	30	70	120	56	7x90	43	St 194.50
Aussengriff	15.145/493 AR	30	70	120	56	7	43	St 194.50

**Fenstergriff Serie Zinal**Eisen verzinkt-altpatiniert
Nocken 10 mm

Bezeichnung	Bestellnummer	\overline{R}_1	\overline{R}_2	\overline{L}_G	\overline{H}	\overline{B}	\overline{D}	CHF
Fenstergriff	15.145/494 FR	33	67	120	67	7x38	43	St 182.50
Fenstertürgriff	15.145/494 IR	33	67	120	67	7x90	43	St 194.50
Aussengriff	15.145/494 AR	33	67	120	67	7	43	St 194.50

**Fenstergriff Serie Spedia**Eisen verzinkt-altpatiniert
Nocken 12 mmHAGER
MULTITAC

Bezeichnung	Bestellnummer	\overline{R}_1	\overline{R}_2	\overline{L}_G	\overline{H}	\overline{B}	\overline{D}	CHF
Fenstergriff	15.146/493 FR	30	70	122	58	7x38	43	St 185.50
Fenstertürgriff	15.146/493 IR	30	70	122	58	7x90	43	St 197.50
Aussengriff	15.146/493 AR	30	70	122	58	7	43	St 197.50

**Fenstergriff Serie Besso**Eisen verzinkt-altpatiniert
Nocken 12 mmHAGER
MULTITAC

Bezeichnung	Bestellnummer	\overline{R}_1	\overline{R}_2	\overline{L}_G	\overline{H}	\overline{B}	\overline{D}	CHF
Fenstergriff	15.148/493 FR	30	70	120	61	7x38	43	St 177.50
Fenstertürgriff	15.148/493 IR	30	70	120	61	7x90	43	St 189.50
Aussengriff	15.148/493 AR	30	70	120	61	7	43	St 189.50

Fenstergriff Serie OchsEisen verzinkt-altpatiniert
Nocken 12 mm

Bezeichnung	Bestellnummer							CHF
Fenstergriff	15.168/499 FR	30	81	110	65	7x38	43	St 201.50
Fenstertürgriff	15.168/499 IR	30	81	110	65	7x90	43	St 213.50
Aussengriff	15.168/499 AR	30	81	110	65	7	43	St 213.50

**Fenstergriff Serie Dom**Eisen verzinkt-altpatiniert
Nocken 12 mm

Bezeichnung	Bestellnummer							CHF
Fenstergriff	15.184/495 FR	30	80	125	65	7x38	43	St 169.50
Fenstertürgriff	15.184/495 IR	30	80	125	65	7x90	43	St 181.50
Aussengriff	15.184/495 AR	30	80	125	65	7	43	St 181.50

**Fenstergriff Serie Pollux**Eisen verzinkt-altpatiniert
Nocken 12 mm

Bezeichnung	Bestellnummer							CHF
Fenstergriff	15.186/495 FR	30	80	120	60	7x38	43	St 183.00
Fenstertürgriff	15.186/495 IR	30	80	120	60	7x90	43	St 195.00
Aussengriff	15.186/495 AR	30	80	120	60	7	43	St 195.00

**Fenstergriff Serie Combin**Eisen verzinkt-altpatiniert
Nocken 10 mm

Bezeichnung	Bestellnummer							CHF
Fenstergriff	15.188/496 FR	33	67	130	77	7x38	43	St 173.50
Fenstertürgriff	15.188/496 IR	33	67	130	77	7x90	43	St 185.50
Aussengriff	15.188/496 AR	33	67	130	77	7	43	St 185.50



**Fenstergriff Serie Combin**Eisen verzinkt-altpatiniert
Nocken 12 mm

Bezeichnung	Bestellnummer	\overline{R}_1	\overline{R}	\overline{G}	H	\square	\circ	CHF
Fenstergriff	15.188/498 FR	30	70	130	59	7x38	43	St 173.50
Fenstertürgriff	15.188/498 IR	30	70	130	59	7x90	43	St 185.50
Aussengriff	15.188/498 AR	30	70	130	59	7	43	St 185.50

**Rosette mit Druckknopf**Eisen verzinkt-altpatiniert
Nocken 10 mm

Bezeichnung	Bestellnummer	H	I	H	\square	\circ	CHF
Rosette mit Druckknopf	15.494 SV	33	67	17	7x38	43	St 143.50

**Rosette mit Druckknopf**Eisen verzinkt-altpatiniert
Nocken 10 mm

Bezeichnung	Bestellnummer	H	I	H	\square	\circ	CHF
Rosette mit Druckknopf	15.496 SV	33	67	17	7x38	43	St 143.50

**Aussengriff gekröpft Serie Pollux**

Eisen verzinkt-altpatiniert



Bezeichnung	Bestellnummer	\overline{R}_1	\overline{R}	\overline{G}	H	\square	\circ	CHF
Aussengriff gekröpft	15.186G/495 AR Ls	30	80	120	60	7	43	St 225.50
Aussengriff gekröpft	15.186G/495 AR Rs	30	80	120	60	7	43	St 225.50

**Aussengriff mit kurzem Hals Serie Pollux**

Eisen verzinkt-altpatiniert





Bezeichnung	Bestellnummer	\overline{R}_1	\overline{R}	\overline{G}	H	\square	\circ	CHF
Aussengriff mit kurzem Hals	15.186N/495L A	25	75	120	30	7	43	St 158.50

Muschelgriff







Eisen verzinkt-altpatiniert

Bezeichnung	Bestellnummer							CHF
Muschelgriff	15.474 A	20	90	25	75	2	St	29.50

**Muschelgriff**Eisen verzinkt-altpatiniert
für Hebeschiebefenster und -Türen

Bezeichnung	Bestellnummer								CHF
Muschelgriff	15.475 A	37	151	3	12	80	M6	St	93.00

**Muschelgriff**Eisen verzinkt-altpatiniert
für Hebeschiebefenster und -Türen

Bezeichnung	Bestellnummer								CHF
Muschelgriff	15.476 A	40	150	2	9	80	M6	St	72.50



**Hebeschiebetürgriff Serie Zupò**

Eisen verzinkt-altpatiniert

Bezeichnung	Bestellnummer							CHF
Hebeschiebetürgriff	15.142HS/147K	40	160	220	63	10x95	80	St 357.50

Bei Bestellung Schraubengrösse angeben: M5x80 / M5x100 / M6x080 / M6x100

**Hebeschiebetürgriff Serie Alv**

Eisen verzinkt-altpatiniert

Bezeichnung	Bestellnummer							CHF
Hebeschiebetürgriff	15.144HS/147K	40	160	210	58	10x95	80	St 362.50

Bei Bestellung Schraubengrösse angeben: M5x80 / M5x100 / M6x080 / M6x100

Hebeschiebetürgriff Serie Spedia







Eisen verzinkt-altpatiniert

Bezeichnung	Bestellnummer							CHF
Hebeschiebetürgriff	15.146HS/147K	40	160	210	60	10x95	80	St 347.50

Bei Bestellung Schraubengrösse angeben: M5x80 / M5x100 / M6x080 / M6x100

**Hebeschiebetürgriff Serie Besso**

Eisen verzinkt-altpatiniert

Bezeichnung	Bestellnummer							CHF
Hebeschiebetürgriff	15.148HS/147K	40	160	223	60	10x95	80	St 357.50

Bei Bestellung Schraubengrösse angeben: M5x80 / M5x100 / M6x080 / M6x100



**Hebeschiebetürgriff Serie Dom**

Eisen verzinkt-altpatiniert

Bezeichnung	Bestellnummer							CHF
Hebeschiebetürgriff	15.184HS/187K	40	170	225	76	10x95	80	St 359.00

Bei Bestellung Schraubengrösse angeben: M5x80 / M5x100 / M6x080 / M6x100

**Hebeschiebetürgriff Serie Pollux**



Eisen verzinkt-altpatiniert

Bezeichnung	Bestellnummer							CHF
Hebeschiebetürgriff	15.186HS/187K	40	170	210	85	10x95	80	St 344.00

Bei Bestellung Schraubengrösse angeben: M5x80 / M5x100 / M6x080 / M6x100

Hebeschiebetürgriff Serie Combin

Eisen verzinkt-altpatiniert

Bezeichnung	Bestellnummer							CHF
Hebeschiebetürgriff	15.188HS/191K	40	160	225	73	10x95	80	St 382.00

Bei Bestellung Schraubengrösse angeben: M5x80 / M5x100 / M6x080 / M6x100

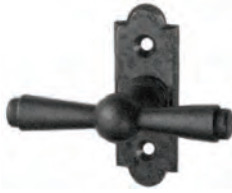

**Fensterolive Serie Dom**Eisen verzinkt-altpatiniert
ohne Nocken

Bezeichnung	Bestellnummer	\overline{R}	\overline{R}	\overline{G}	\overline{H}	\overline{Z}	\overline{O}	CHF
Fensterolive	15.444/495L F	25	75	100	52	7x38	43	St 100.50
Fensterolive mit Rastung	15.444/495 FR	30	80	100	52	7x38	43	St 142.50

**Fensterolive Serie Alv**Eisen verzinkt-altpatiniert
ohne Nocken

Bezeichnung	Bestellnummer	\overline{R}	\overline{R}	\overline{G}	\overline{H}	\overline{Z}	\overline{O}	CHF
Fensterolive	15.446/493L F	25	66	84	45	7x38	43	St 107.50
Fensterolive mit Rastung	15.446/493 FR	30	70	84	45	7x38	43	St 149.50

**Fensterolive Serie Zupò**Eisen verzinkt-altpatiniert
ohne Nocken

Bezeichnung	Bestellnummer	\overline{R}	\overline{R}	\overline{G}	\overline{H}	\overline{Z}	\overline{O}	CHF
Fensterolive	15.447/493L F	25	66	80	47	7x38	43	St 92.00
Fensterolive mit Rastung	15.447/493 FR	30	70	80	47	7x38	43	St 150.00

**Fensterolive Serie Spedia**Eisen verzinkt-altpatiniert
ohne Nocken

Bezeichnung	Bestellnummer	\overline{R}	\overline{R}	\overline{G}	\overline{H}	\overline{Z}	\overline{O}	CHF
Fensterolive	15.448/493L F	25	66	70	46	7x38	43	St 92.00
Fensterolive mit Rastung	15.448/493 FR	30	70	70	46	7x38	43	St 150.00

**Fensterolive Serie Pollux**Eisen verzinkt-altpatiniert
ohne Nocken

Bezeichnung	Bestellnummer	\overline{R}	\overline{R}	\overline{G}	\overline{H}	\overline{Z}	\overline{O}	CHF
Fensterolive	15.457/495L F	25	75	76	44	7x38	43	St 92.00
Fensterolive mit Rastung	15.457/495 FR	30	80	76	44	7x38	43	St 150.00

**Fensterolive Serie Combin**Eisen verzinkt-altpatiniert
ohne Nocken

Bezeichnung	Bestellnummer	\overline{R}	\overline{R}	\overline{G}	\overline{H}	\overline{Z}	\overline{O}	CHF
Fensterolive	15.488/498L F	25	76	106	54	7x38	43	St 108.50
Fensterolive mit Rastung	15.488/498 FR	30	70	106	54	7x38	43	St 150.50

Fenstergriff Serie Zupò

Eisen gerostet
Nocken 12 mm



Bezeichnung	Bestellnummer							CHF
Fenstergriff	16.142/493 FR	30	70	120	63	7x38	43	St 194.00
Fenstertürgriff	16.142/493 IR	30	70	120	63	7x90	43	St 206.00



Fenstergriff Serie Zupò

Eisen gerostet
Nocken 10 mm

Bezeichnung	Bestellnummer							CHF
Fenstergriff	16.142/496 FR	33	67	120	75	7x38	43	St 194.00
Fenstertürgriff	16.142/496 IR	33	67	120	75	7x90	43	St 206.00



Fenstergriff Serie Alv

Eisen gerostet
Nocken 12 mm



Bezeichnung	Bestellnummer							CHF
Fenstergriff	16.144/493 FR	30	70	120	53	7x38	43	St 193.00
Fenstertürgriff	16.144/493 IR	30	70	120	53	7x90	43	St 205.00



Fenstergriff Serie Alv

Eisen gerostet
Nocken 10 mm

Bezeichnung	Bestellnummer							CHF
Fenstergriff	16.144/494 FR	33	67	120	64	7x38	43	St 193.00
Fenstertürgriff	16.144/494 IR	33	67	120	64	7x90	43	St 205.00



3

**Fenstergriff Serie Zinal**Eisen gerostet
Nocken 12 mmHAGER
MULTITAC

Bezeichnung	Bestellnummer							CHF
Fenstergriff	16.145/493 FR	30	70	120	56	7x38	43	St 189.00
Fenstertürgriff	16.145/493 IR	30	70	120	56	7x90	43	St 201.00

**Fenstergriff Serie Zinal**Eisen gerostet
Nocken 10 mm

Bezeichnung	Bestellnummer							CHF
Fenstergriff	16.145/494 FR	33	67	120	67	7x38	43	St 189.00
Fenstertürgriff	16.145/494 IR	33	67	120	67	7x90	43	St 201.00

**Fenstergriff Serie Spedia**Eisen gerostet
Nocken 12 mmHAGER
MULTITAC

Bezeichnung	Bestellnummer							CHF
Fenstergriff	16.146/493 FR	30	70	122	58	7x38	43	St 192.00
Fenstertürgriff	16.146/493 IR	30	70	122	58	7x90	43	St 204.00

**Fenstergriff Serie Besso**Eisen gerostet
Nocken 12 mmHAGER
MULTITAC

Bezeichnung	Bestellnummer							CHF
Fenstergriff	16.148/493 FR	30	70	120	61	7x38	43	St 184.00
Fenstertürgriff	16.148/493 IR	30	70	120	61	7x90	43	St 196.00

Fenstergriff Serie OchsEisen gerostet
Nocken 12 mm

Bezeichnung	Bestellnummer							CHF
Fenstergriff	16.168/499 FR	30	81	110	65	7x38	43	St 216.00
Fenstertürgriff	16.168/499 IR	30	81	110	65	7x90	43	St 228.00

**Fenstergriff Serie Dom**Eisen gerostet
Nocken 12 mm

Bezeichnung	Bestellnummer							CHF
Fenstergriff	16.184/495 FR	30	80	125	65	7x38	43	St 176.00
Fenstertürgriff	16.184/495 IR	30	80	125	65	7x90	43	St 188.00

**Fenstergriff Serie Pollux**Eisen gerostet
Nocken 12 mm

Bezeichnung	Bestellnummer							CHF
Fenstergriff	16.186/495 FR	30	80	120	60	7x38	43	St 189.50
Fenstertürgriff	16.186/495 IR	30	80	120	60	7x90	43	St 201.50

**Fenstergriff Serie Combin**Eisen gerostet
Nocken 10 mm

Bezeichnung	Bestellnummer							CHF
Fenstergriff	16.188/496 FR	33	67	130	77	7x38	43	St 180.00
Fenstertürgriff	16.188/496 IR	33	67	130	77	7x90	43	St 192.00



**Fenstergriff Serie Combin**Eisen gerostet
Nocken 12 mmHAGER
MULTITAC

Bezeichnung	Bestellnummer	H	I	G	H	□	⊕	CHF
Fenstergriff	16.188/498 FR	30	70	130	59	7x38	43	St 180.00
Fenstertürgriff	16.188/498 IR	30	70	130	59	7x90	43	St 192.00

**Rosette mit Druckknopf**Eisen gerostet
Nocken 10 mm

Bezeichnung	Bestellnummer	H	I	H	□	⊕	CHF
Rosette mit Druckknopf	16.494 SV	33	67	17	7x38	43	St 146.50

**Rosette mit Druckknopf**Eisen gerostet
Nocken 10 mm

Bezeichnung	Bestellnummer	H	I	H	□	⊕	CHF
Rosette mit Druckknopf	16.496 SV	33	67	17	7x38	43	St 146.50

Hebeschiebetürgriff Serie Zupò

Eisen gerostet

Bezeichnung	Bestellnummer							CHF
Hebeschiebetürgriff	16.142HS/147K	40	160	220	63	10x95	80	St 375.50

Bei Bestellung Schraubengrösse angeben: M5x80 / M5x100 / M6x080 / M6x100

Hebeschiebetürgriff Serie Alv

Eisen gerostet

Bezeichnung	Bestellnummer							CHF
Hebeschiebetürgriff	16.144HS/147K	40	160	210	58	10x95	80	St 380.50

Bei Bestellung Schraubengrösse angeben: M5x80 / M5x100 / M6x080 / M6x100



**Hebeschiebetürgriff Serie Spedia**

Eisen gerostet

Bezeichnung	Bestellnummer							CHF
Hebeschiebetürgriff	16.146HS/147K	40	160	210	60	10x95	80	St 365.50

Bei Bestellung Schraubengrösse angeben: M5x80 / M5x100 / M6x080 / M6x100

**Hebeschiebetürgriff Serie Besso**

Eisen gerostet

Bezeichnung	Bestellnummer							CHF
Hebeschiebetürgriff	16.148HS/147K	40	160	223	60	10x95	80	St 375.50

Bei Bestellung Schraubengrösse angeben: M5x80 / M5x100 / M6x080 / M6x100

Hebeschiebetürgriff Serie Dom

Eisen gerostet

Bezeichnung	Bestellnummer							CHF
Hebeschiebetürgriff	16.184HS/187K	40	170	225	76	10x95	80	St 377.00



Bei Bestellung Schraubengrösse angeben: M5x80 / M5x100 / M6x080 / M6x100



3

Hebeschiebetürgriff Serie Pollux

Eisen gerostet

Bezeichnung	Bestellnummer							CHF
Hebeschiebetürgriff	16.186HS/187K	40	170	210	85	10x95	80	St 362.00

Bei Bestellung Schraubengrösse angeben: M5x80 / M5x100 / M6x080 / M6x100









**Hebeschiebetürgriff Serie Combin**

Eisen gerostet







Bezeichnung	Bestellnummer							CHF
Hebeschiebetürgriff	16.188HS/191K	40	160	225	73	10x95	80	St 400.00

Bei Bestellung Schraubengrösse angeben: M5x80 / M5x100 / M6x080 / M6x100







Fensterolive Serie DomEisen gerostet
ohne Nocken

Bezeichnung	Bestellnummer							CHF
Fensterolive	16.444/495L F	25	75	100	52	7x38	43	St 104.50
Fensterolive mit Rastung	16.444/495 FR	30	80	100	52	7x38	43	St 146.50







Fensterolive Serie AlvEisen gerostet
ohne Nocken

Bezeichnung	Bestellnummer							CHF
Fensterolive	16.446/493L F	25	66	84	45	7x38	43	St 111.50
Fensterolive mit Rastung	16.446/493 FR	30	70	84	45	7x38	43	St 153.50







Fensterolive Serie ZupòEisen gerostet
ohne Nocken

Bezeichnung	Bestellnummer							CHF
Fensterolive	16.447/493L F	25	66	80	46	7x38	43	St 96.00
Fensterolive mit Rastung	16.447/493 FR	30	70	80	46	7x38	43	St 154.00

Fensterolive Serie SpediaEisen gerostet
ohne Nocken

Bezeichnung	Bestellnummer							CHF
Fensterolive	16.448/493L F	25	66	70	46	7x38	43	St 96.00
Fensterolive mit Rastung	16.448/493 FR	30	70	70	46	7x38	43	St 154.00

Fensterolive Serie PolluxEisen gerostet
ohne Nocken

Bezeichnung	Bestellnummer							CHF
Fensterolive	16.449/492 F	31	94	85	46	7x38	43	St 96.00
Fensterolive mit Rastung	16.449/492 FR	31	94	85	46	7x38	43	St 157.00

FensteroliveEisen gerostet
ohne Nocken

Bezeichnung	Bestellnummer							CHF
Fensterolive	16.451 F	25	130	85	47	7x38	43	St 96.00

FensteroliveEisen gerostet
ohne Nocken

Bezeichnung	Bestellnummer							CHF
Fensterolive	16.452 F	20	92	58	45	7x38	43	St 96.00



**Fensterolive**Eisen gerostet
ohne Nocken

Bezeichnung	Bestellnummer							CHF
Fensterolive	16.456/495L F	25	75	87	47	7x38	43	St 104.50
Fensterolive mit Rastung	16.456/495 FR	30	80	87	47	7x38	43	St 146.50

**Fensterolive Serie Pollux**Eisen gerostet
ohne Nocken

Bezeichnung	Bestellnummer							CHF
Fensterolive	16.457/495L F	25	75	76	44	7x38	43	St 96.00
Fensterolive mit Rastung	16.457/495 FR	30	80	76	44	7x38	43	St 154.00

**Fensterolive Serie Combin**Eisen gerostet
ohne Nocken

Bezeichnung	Bestellnummer							CHF
Fensterolive	16.488/498L F	25	76	106	54	7x38	43	St 112.50
Fensterolive mit Rastung	16.488/498 FR	30	70	106	54	7x38	43	St 154.50

Fenstergriff Serie SpesBronze dunkel
Nocken 10 mm

Bezeichnung	Bestellnummer	FR	IR	IG	H	W	Ø	CHF
Fenstergriff links	80.1103/1562 FR Ls	38	71	160	69	7x38	43	St 240.50
Fenstergriff rechts	80.1103/1562 FR Rs	38	71	160	69	7x38	43	St 240.50
Fenstertürgriff links	80.1103/1562 IR Ls	38	71	160	69	7x90	43	St 252.50
Fenstertürgriff rechts	80.1103/1562 IR Rs	38	71	160	69	7x90	43	St 252.50
Aussengriff links	80.1103/1562 AR Ls	38	71	160	69	7	43	St 252.50
Aussengriff rechts	80.1103/1562 AR Rs	38	71	160	69	7	43	St 252.50

**Fenstergriff Serie Quadrum**Bronze dunkel
Nocken 10 mm

Bezeichnung	Bestellnummer	FR	IR	IG	H	W	Ø	CHF
Fenstergriff	80.1135/1562 FR	38	71	127	68	7x38	43	St 240.50
Fenstertürgriff	80.1135/1562 IR	38	71	127	68	7x90	43	St 252.50
Aussengriff	80.1135/1562 AR	38	71	127	68	7	43	St 252.50

**Fenstergriff Serie Latus**Bronze dunkel
Nocken 10 mm

Bezeichnung	Bestellnummer	FR	IR	IG	H	W	Ø	CHF
Fenstergriff	80.1138/1562 FR	38	71	135	60	7x38	43	St 240.50
Fenstertürgriff	80.1138/1562 IR	38	71	135	60	7x90	43	St 252.50
Aussengriff	80.1138/1562 AR	38	71	135	60	7	43	St 252.50

**Fenstergriff Serie Simplex**Bronze dunkel
Nocken 10 mm

Bezeichnung	Bestellnummer	FR	IR	IG	H	W	Ø	CHF
Fenstergriff	80.1139/1562 FR	38	71	140	67	7x38	43	St 240.50
Fenstertürgriff	80.1139/1562 IR	38	71	140	67	7x90	43	St 252.50
Aussengriff	80.1139/1562 AR	38	71	140	67	7	43	St 252.50



**Fenstergriff Serie Suculus**Bronze dunkel
Nocken 10 mm

Bezeichnung	Bestellnummer							CHF
Fenstergriff	80.1139R/1562 FR	38	71	140	67	7x38	43	St 275.50
Fenstertürgriff	80.1139R/1562 IR	38	71	140	67	7x90	43	St 287.50
Aussengriff	80.1139R/1562 AR	38	71	140	67	7	43	St 287.50

**Fenstergriff Serie Angulum**Bronze dunkel
Nocken 10 mm

Bezeichnung	Bestellnummer							CHF
Fenstergriff	80.1144/1562 FR	38	71	137	61	7x38	43	St 240.50
Fenstertürgriff	80.1144/1562 IR	38	71	137	61	7x90	43	St 252.50
Aussengriff	80.1144/1562 AR	38	71	137	61	7	43	St 252.50

**Fenstergriff Serie Tempus**Bronze dunkel
Nocken 10 mm

Bezeichnung	Bestellnummer							CHF
Fenstergriff	80.1155/1561 FR	35	70	130	82	7x38	43	St 240.50
Fenstertürgriff	80.1155/1561 IR	35	70	130	82	7x90	43	St 252.50
Aussengriff	80.1155/1561 AR	35	70	130	82	7	43	St 252.50

**Fenstergriff Serie Pax**Bronze dunkel
Nocken 10 mm

Bezeichnung	Bestellnummer							CHF
Fenstergriff links	80.1294/1561 FR Ls	35	70	130	63	7x38	43	St 240.50
Fenstergriff rechts	80.1294/1561 FR Rs	35	70	130	63	7x38	43	St 240.50
Fenstertürgriff links	80.1294/1561 IR Ls	35	70	130	63	7x90	43	St 252.50
Fenstertürgriff rechts	80.1294/1561 IR Rs	35	70	130	63	7x90	43	St 252.50
Aussengriff links	80.1294/1561 AR Ls	35	70	130	63	7	43	St 252.50
Aussengriff rechts	80.1294/1561 AR Rs	35	70	130	63	7	43	St 252.50

Hebeschiebetürgriff Serie Spes

Bronze dunkel



Bezeichnung	Bestellnummer							CHF
Hebeschiebetürgriff	80.1103HS/1047K Ls	35	154	250	70	10x40	80	St 625.00
Hebeschiebetürgriff	80.1103HS/1047K Rs	35	154	250	70	10x40	80	St 625.00

Bei Bestellung Schraubengrösse angeben: M5x80 / M5x100 / M6x080 / M6x100

**Hebeschiebetürgriff Serie Quadrum**

Bronze dunkel



Bezeichnung	Bestellnummer							CHF
Hebeschiebetürgriff	80.1135HS/1047K	35	154	240	69	10x40	80	St 625.00

Bei Bestellung Schraubengrösse angeben: M5x80 / M5x100 / M6x080 / M6x100



**Hebeschiebetürgriff Serie Latus**

Bronze dunkel



Bezeichnung	Bestellnummer							CHF
Hebeschiebetürgriff	80.1138HS/1047K	35	154	240	82	10x40	80	St 625.00

Bei Bestellung Schraubengrösse angeben: M5x80 / M5x100 / M6x080 / M6x100

Fenstergriff Serie SpesBronze versilbert
Nocken 10 mm

Bezeichnung	Bestellnummer	\overline{R}_1	\overline{R}	\overline{T}_G	H	□	o-o	CHF
Fenstergriff links	83.1103/1562 FR Ls	38	71	160	69	7x38	43	St 310.50
Fenstergriff rechts	83.1103/1562 FR Rs	38	71	160	69	7x38	43	St 310.50
Fenstertürgriff links	83.1103/1562 IR Ls	38	71	160	69	7x90	43	St 322.50
Fenstertürgriff rechts	83.1103/1562 IR Rs	38	71	160	69	7x90	43	St 322.50
Aussengriff links	83.1103/1562 AR Ls	38	71	160	69	7	43	St 322.50
Aussengriff rechts	83.1103/1562 AR Rs	38	71	160	69	7	43	St 322.50

**Fenstergriff Serie Quadrum**Bronze versilbert
Nocken 10 mm

Bezeichnung	Bestellnummer	\overline{R}_1	\overline{R}	\overline{T}_G	H	□	o-o	CHF
Fenstergriff	83.1135/1562 FR	38	71	127	68	7x38	43	St 310.50
Fenstertürgriff	83.1135/1562 IR	38	71	127	68	7x90	43	St 322.50
Aussengriff	83.1135/1562 AR	38	71	127	68	7	43	St 322.50

**Fenstergriff Serie Latus**Bronze versilbert
Nocken 10 mm

Bezeichnung	Bestellnummer	\overline{R}_1	\overline{R}	\overline{T}_G	H	□	o-o	CHF
Fenstergriff	83.1138/1562 FR	38	71	135	60	7x38	43	St 310.50
Fenstertürgriff	83.1138/1562 IR	38	71	135	60	7x90	43	St 322.50
Aussengriff	83.1138/1562 AR	38	71	135	60	7	43	St 322.50

**Fenstergriff Serie Simplex**Bronze versilbert
Nocken 10 mm

Bezeichnung	Bestellnummer	\overline{R}_1	\overline{R}	\overline{T}_G	H	□	o-o	CHF
Fenstergriff	83.1139/1562 FR	38	71	140	67	7x38	43	St 310.50
Fenstertürgriff	83.1139/1562 IR	38	71	140	67	7x90	43	St 322.50
Aussengriff	83.1139/1562 AR	38	71	140	67	7	43	St 322.50



**Fenstergriff Serie Suculus**

Bronze versilbert
Nocken 10 mm



Bezeichnung	Bestellnummer							CHF
Fenstergriff	83.1139R/1562 FR	38	71	140	67	7x38	43	St 350.50
Fenstertürgriff	83.1139R/1562 IR	38	71	140	67	7x90	43	St 362.50
Aussengriff	83.1139R/1562 AR	38	71	140	67	7	43	St 362.50

**Fenstergriff Serie Angulum**

Bronze versilbert
Nocken 10 mm



Bezeichnung	Bestellnummer							CHF
Fenstergriff	83.1144/1562 FR	38	71	137	61	7x38	43	St 310.50
Fenstertürgriff	83.1144/1562 IR	38	71	137	61	7x90	43	St 322.50
Aussengriff	83.1144/1562 AR	38	71	137	61	7	43	St 322.50

**Fenstergriff Serie Tempus**

Bronze versilbert
Nocken 10 mm



Bezeichnung	Bestellnummer							CHF
Fenstergriff	83.1155/1561 FR	35	70	130	82	7x38	43	St 310.50
Fenstertürgriff	83.1155/1561 IR	35	70	130	82	7x90	43	St 322.50
Aussengriff	83.1155/1561 AR	35	70	130	82	7	43	St 322.50

**Fenstergriff Serie Pax**

Bronze versilbert
Nocken 10 mm



Bezeichnung	Bestellnummer							CHF
Fenstergriff links	83.1294/1561 FR Ls	35	70	130	63	7x38	43	St 310.50
Fenstergriff rechts	83.1294/1561 FR Rs	35	70	130	63	7x38	43	St 310.50
Fenstertürgriff links	83.1294/1561 IR Ls	35	70	130	63	7x90	43	St 322.50
Fenstertürgriff rechts	83.1294/1561 IR Rs	35	70	130	63	7x90	43	St 322.50
Aussengriff links	83.1294/1561 AR Ls	35	70	130	63	7	43	St 322.50
Aussengriff rechts	83.1294/1561 AR Rs	35	70	130	63	7	43	St 322.50

Hebeschiebetürgriff Serie Spes

Bronze versilbert



Bezeichnung	Bestellnummer							CHF
Hebeschiebetürgriff	83.1103HS/1047K Ls	35	154	250	70	10x40	80	St 820.00
Hebeschiebetürgriff	83.1103HS/1047K Rs	35	154	250	70	10x40	80	St 820.00

Bei Bestellung Schraubengrösse angeben: M5x80 / M5x100 / M6x080 / M6x100

**Hebeschiebetürgriff Serie Quadrum**

Bronze versilbert



Bezeichnung	Bestellnummer							CHF
Hebeschiebetürgriff	83.1135HS/1047K	35	154	240	69	10x40	80	St 820.00

Bei Bestellung Schraubengrösse angeben: M5x80 / M5x100 / M6x080 / M6x100



**Hebeschiebetürgriff Serie Latus**

Bronze versilbert



Bezeichnung	Bestellnummer							CHF
Hebeschiebetürgriff	83.1138HS/1047K	35	154	240	82	10x40	80	St 820.00

Bei Bestellung Schraubengrösse angeben: M5x80 / M5x100 / M6x080 / M6x100

Eisen naturblank
Eisen verzinkt-allpatiniert
Eisen gerostet

Seite 4.02
Seite 4.08
Seite 4.17

Verschlussriegel für Fenstertüren

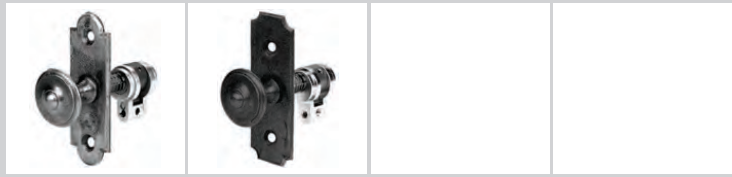

Eisen naturblank
Eisen verzinkt-allpatiniert
Eisen gerostet

Seite 4.02
Seite 4.08
Seite 4.17

Zylinderrosetten für Fenstertüren

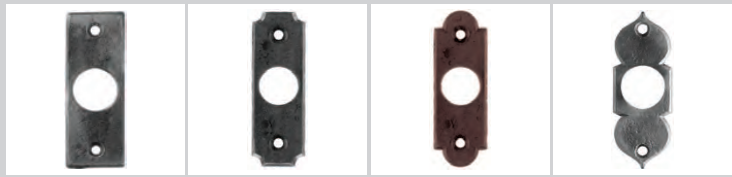

Eisen naturblank

Seite 4.02

Steckgriffe und Steckrosetten

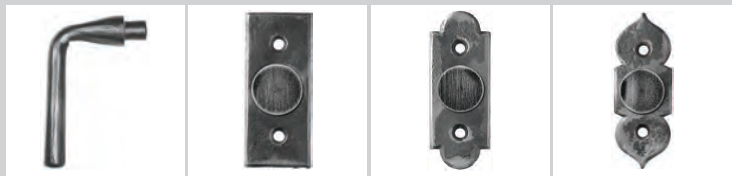

Eisen naturblank
Eisen verzinkt-allpatiniert
Eisen gerostet
Eisen blank

Seite 4.03
Seite 4.08
Seite 4.17
Seite 4.18

Diverse Fensterbeschläge

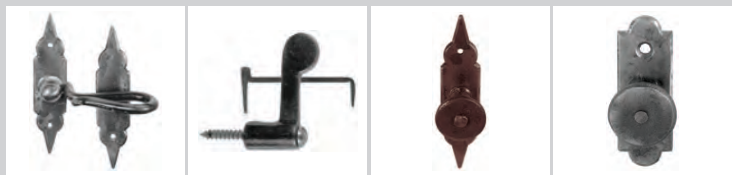

Eisen naturblank
Eisen verzinkt-allpatiniert
Eisen gerostet

Seite 4.05
Seite 4.09
Seite 4.18

Fensterbänder

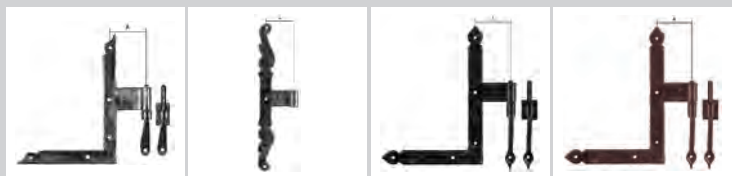

Eisen verzinkt-allpatiniert

Seite 4.09

Jalousiebeschläge handgeschmiedet



Eisen verzinkt-allpatiniert

Seite 4.12

Jalousiebeschläge standard

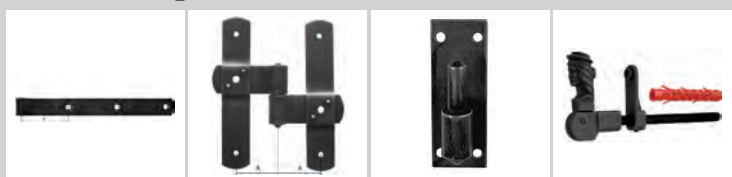

**Verschlussriegel**

Eisen naturblank

Bezeichnung	Bestellnummer	H	LB	TR	H	∞	CHF
Verschlussriegel	13.495 VR	35	30	80	37	63	St 131.80

**Verschlussriegel**

Eisen naturblank

Bezeichnung	Bestellnummer	H	LB	TR	H	∞	CHF
Verschlussriegel	13.498H VR	35	30	80	37	63	St 131.80

**Zylinderrosetten für Fenstertüren**

Eisen naturblank

Bezeichnung	Bestellnummer	H	I	H	∞	CHF
RZ Rosette innen	13.493H I RZ	30	82	3	63	St 37.00
PZ Rosette innen	13.493H I PZ	30	82	3	63	St 37.00

**Zylinderrosetten für Fenstertüren**

Eisen naturblank

Bezeichnung	Bestellnummer	H	I	H	∞	CHF
RZ Rosette innen	13.495 I RZ	30	80	3	63	St 37.00
PZ Rosette innen	13.495 I PZ	30	80	3	63	St 37.00

**Zylinderrosetten für Fenstertüren**

Eisen naturblank

Bezeichnung	Bestellnummer	H	I	H	∞	CHF
RZ Rosette innen	13.498H I RZ	30	80	3	63	St 37.00
PZ Rosette innen	13.498H I PZ	30	80	3	63	St 37.00

**Zylinderrosetten für Fenstertüren**

Eisen naturblank

Bezeichnung	Bestellnummer	H	I	H	∞	CHF
RZ Rosette innen	13.499 I RZ	30	81	3	63	St 37.00
PZ Rosette innen	13.499 I PZ	30	81	3	63	St 37.00

**Steckgriff Serie Pollux**

Eisen naturblank

Bezeichnung	Bestellnummer	H	IG	H	∅	□	CHF
Steckgriff	13.186 STG	22	120	57	15	7	St 129.00

Steckrosette mit Blindstopfen

Eisen naturblank

Bezeichnung	Bestellnummer	H	I	H	∞	CHF
Steckrosette mit Blindstopfen	13.493 STB	30	70	5	43	St 89.50



Steckrosette mit Blindstopfen

Eisen naturblank

Bezeichnung	Bestellnummer	H	I	H	∞	CHF
Steckrosette mit Blindstopfen	13.495 STB	30	80	5	43	St 89.50



Steckrosette mit Blindstopfen

Eisen naturblank

Bezeichnung	Bestellnummer	H	I	H	∞	CHF
Steckrosette mit Blindstopfen	13.498 STB	30	70	5	43	St 89.50



Steckrosette mit Blindstopfen

Eisen naturblank

Bezeichnung	Bestellnummer	H	I	H	∞	CHF
Steckrosette mit Blindstopfen	13.499 STB	30	81	5	43	St 96.00



Fenstervorreiber mit Streicher

Eisen naturblank

Bezeichnung	Bestellnummer	H	I	∅	≠	CHF
Fenstervorreiber mit Streicher 13.421 S	13.421	60	16	6	18	St 53.50



Fenstervorreiber mit Streicherplatte

Eisen naturblank

Bezeichnung	Bestellnummer	I _R	I _R	I _G	∅	≠	CHF
Fenstervorreiber mit Streicherplatte	13.422	20	90	60	6	18	St 85.00



Gussvorreiber mit Streicher

Eisen naturblank

Bezeichnung	Bestellnummer	H	I	H	≠	CHF	
Gussvorreiber mit Streicher	13.424	14	55	39	18	6	St 24.50



Doppelvorreiber mit 2 Streicher

Eisen naturblank

Bezeichnung	Bestellnummer	H	I	∅	≠	CHF
Doppelvorreiber mit 2 Streicher	13.425	110	16	6	18	St 75.00



4

**Fenstervorreiber mit Streicher**

Eisen naturblank

Bezeichnung	Bestellnummer	H	I	≠	CHF
Fenstervorreiber mit Streicher 13.421 S	13.426	11	52	18	St 56.00

Fenstervorreiber mit Streicher geschmiedet

Eisen naturblank

Bezeichnung	Bestellnummer	H	I	≠	CHF
Fenstervorreiber mit Streicher geschmiedet	13.427	11	52	18	St 92.50

Doppelvorreiber mit 2 Streicher

Eisen naturblank

Bezeichnung	Bestellnummer	H	I	≠	CHF
Doppelvorreiber mit 2 Streicher	13.428	90	11	18	St 85.00

Oberlichtschnäpper

Eisen naturblank

Bezeichnung	Bestellnummer	H	I	H	CHF
Oberlichtschnäpper	13.434	95	65	64	St 105.00

Fensterknopf mit Rosette

Eisen naturblank

Bezeichnung	Bestellnummer	H	B ₁	I	H	∅	CHF
Fensterknopf mit Rosette	13.440	22	25	74	32		St 38.50
Rosette	13.440 R		25	74	2	4.2	St 19.00

Fensterknopf mit Rosette

Eisen naturblank

Bezeichnung	Bestellnummer	H	B ₁	I	H	∅	CHF
Fensterknopf mit Rosette	13.441	25	20	90	29		St 37.50
Rosette	13.441 R		20	90	2	4.2	St 13.50

Fensterknopf mit Rosette

Eisen naturblank

Bezeichnung	Bestellnummer	H	B ₁	I	H	∅	∞	CHF
Fensterknopf mit Rosette	13.443	31	26	76	30			St 48.50
Rosette	13.443 R		26	76	2	4.2	43	St 23.00

Fensterknopf mit Rosette

Eisen naturblank

Bezeichnung	Bestellnummer	H	B ₁	I	H	∅	∞	CHF
Fensterknopf mit Rosette	13.445	25	25	77	30			St 42.50
Rosette	13.445 R		25	77	2	4.2	43	St 26.00

Fenstermittelband

Eisen naturblank

Bezeichnung	Bestellnummer	I	∅	≠	≠	▨	A	CHF
Fenstermittelband	13.400/140 M	140	6	15x2			42	St 40.50
Fenstermittelband	13.400/210 M	210	6	20x2			45	St 45.00
Bolzenstützkloben	13.400 D1/140	90	6	18		M6x50		St 22.00
Bolzenstützkloben	13.400 D2/210	115	6	18		M6x50		St 25.00
Bolzenstützkloben mit Platte 20x30mm	13.400 B1/140	90	6	18		M6x50		St 38.50
Bolzenstützkloben mit Platte 20x30mm	13.400 B2/210	115	6	18		M6x50		St 42.50



Fensterwinkelband

Eisen naturblank

Bezeichnung	Bestellnummer	I	∅	≠	≠	▨	A	CHF
Fensterwinkelband links	13.400/140 Ls	140	6	15x2			42	St 40.50
Fensterwinkelband rechts	13.400/140 Rs	140	6	15x2			42	St 40.50
Fensterwinkelband links	13.400/210 Ls	210	6	20x2			45	St 45.00
Fensterwinkelband rechts	13.400/210 Rs	210	6	20x2			45	St 45.00
Bolzenstützkloben	13.400 D1/140	90	6	18		M6x50		St 22.00
Bolzenstützkloben	13.400 D2/210	115	6	18		M6x50		St 25.00
Bolzenstützkloben mit Platte 20x30mm	13.400 B1/140	90	6	18		M6x50		St 38.50
Bolzenstützkloben mit Platte 20x30mm	13.400 B2/210	115	6	18		M6x50		St 42.50

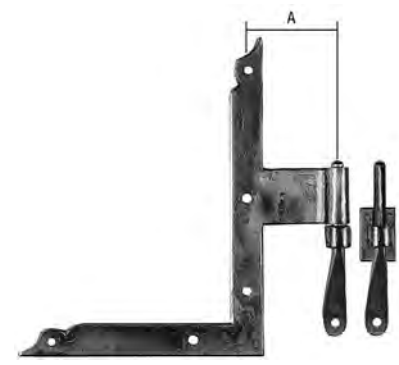

Fensterwinkelband

Eisen naturblank

Bezeichnung	Bestellnummer	I	∅	≠	≠	▨	A	CHF
Fensterwinkelband links	13.401/140 Ls	140	7	20x3			45	St 40.00
Fensterwinkelband rechts	13.401/140 Rs	140	7	20x3			45	St 40.00
Bolzenstützkloben	13.401 D1	110	7	18		M6x50		St 29.00



Fenstermittelband

Eisen naturblank

Bezeichnung	Bestellnummer	I	∅	≠	≠	▨	A	CHF
Fenstermittelband	13.402/190 M	190	7	18	20x3		45	St 40.50
Bolzenstützkloben	13.402 D1	125	7	18		M8x50		St 28.50
Bolzenstützkloben mit Platte 20x30mm	13.402 B1	125	7	18		M8x50		St 45.00
Plattenstützkloben mit Platte 25x70mm	13.402 B2	135	7	18				St 50.00

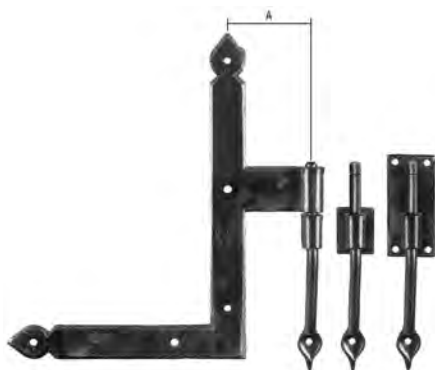

**Fensterwinkelband**

Eisen naturblank

Bezeichnung	Bestellnummer	I	Ø	≠	≠	▨	A	CHF
Fensterwinkelband links	13.402/190 Ls	190	7	18	20x3		45	St 40.50
Fensterwinkelband rechts	13.402/190 Rs	190	7	18	20x3		45	St 40.50
Fensterwinkelband links	13.402/230 Ls	230	7	18	20x3		45	St 48.00
Fensterwinkelband rechts	13.402/230 Rs	230	7	18	20x3		45	St 48.00
Bolzenstützkloben	13.402 D1	125	7	18		M8x50		St 28.50
Bolzenstützkloben mit Platte 20x30mm	13.402 B1	125	7	18		M8x50		St 45.00
Plattenstützkloben mit Platte 25x70mm	13.402 B2	135	7	18				St 50.00

**Fenstermittelband**

Eisen naturblank

Bezeichnung	Bestellnummer	I	Ø	≠	≠	▨	A	CHF
Fenstermittelband	13.403/240 M	240	7	18	20x3		45	St 52.00
Bolzenstützkloben mit Platte 20x34mm	13.403 B2	130	7	18		M8x50		St 52.00
Bolzenstützkloben	13.403 D2	130	7	18		M8x50		St 34.50

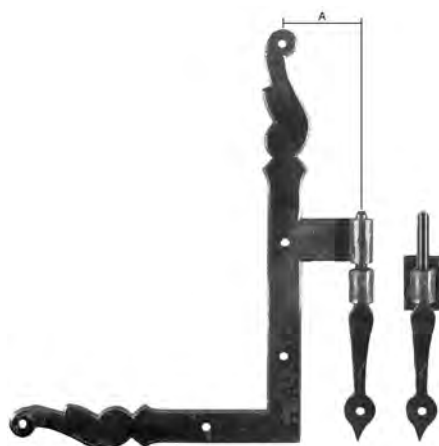
**Fensterwinkelband**

Eisen naturblank

Bezeichnung	Bestellnummer	I	Ø	≠	≠	▨	A	CHF
Fensterwinkelband links	13.403/240 Ls	240	7	18	20x3		45	St 52.00
Fensterwinkelband rechts	13.403/240 Rs	240	7	18	20x3		45	St 52.00
Bolzenstützkloben mit Platte 20x34mm	13.403 B2	130	7	18		M8x50		St 52.00
Bolzenstützkloben	13.403 D2	130	7	18		M8x50		St 34.50

Fenstermittelband

Eisen naturblank

Bezeichnung	Bestellnummer	I	∅	≠	≠	▨	A	St	CHF
Fenstermittelband	13.406/190 M	190	7	18	20x3		45	St	39.50
Bolzenstützkloben	13.406 D1	125	7	18		M8x50		St	28.00
Bolzenstützkloben mit Platte 20x30mm	13.406 B1	125	7	18		M8x50		St	44.50



Fensterwinkelband

Eisen naturblank

Bezeichnung	Bestellnummer	I	∅	≠	≠	▨	A	St	CHF
Fensterwinkelband links	13.406/190 Ls	190	7	18	20x3		45	St	39.50
Fensterwinkelband rechts	13.406/190 Rs	190	7	18	20x3		45	St	39.50
Bolzenstützkloben	13.406 D1	125	7	18		M8x50		St	28.00
Bolzenstützkloben mit Platte 20x30mm	13.406 B1	125	7	18		M8x50		St	44.50

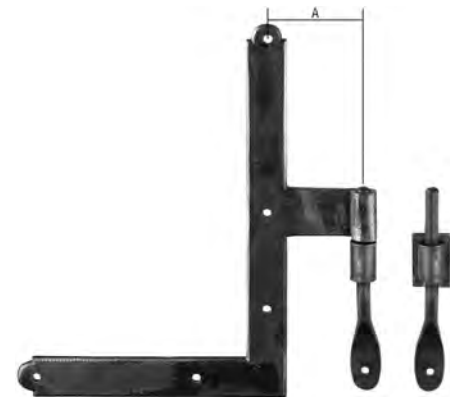

Fensterwinkelband

Eisen naturblank

Kloben mit Einbohrband C 16 Rek - Band als Scheinband

Bezeichnung	Bestellnummer	I	∅	≠	≠	▨	A	St	CHF
Fensterwinkelband links	13.407/230 Ls	230		18	25x2		45	St	46.00
Fensterwinkelband rechts	13.407/230 Rs	230		18	25x2		45	St	46.00
Bolzenstützkloben	13.407 D	130	8	18		40/40		St	39.50
Plattenstützkloben mit Platte 25x70mm	13.407 B	130	8	18		40/40		St	61.50

bis Flügelbreite 800 mm und Flügelgewicht 50 kg (bei 2 Kloben)

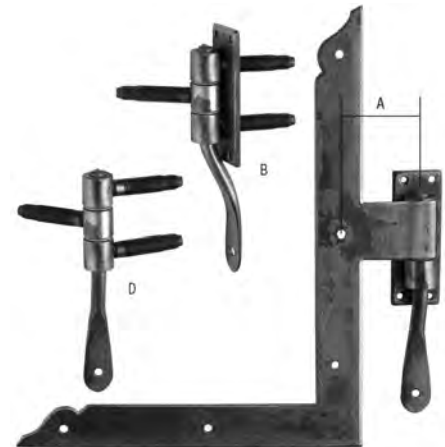

**Verschlussriegel**

Eisen verzinkt-altpatiniert

Bezeichnung	Bestellnummer	H	I	R	H	∅	CHF
Verschlussriegel	15.495 VR	35	30	80	37	63	St 142.30

**Verschlussriegel**

Eisen verzinkt-altpatiniert

Bezeichnung	Bestellnummer	H	I	R	H	∅	CHF
Verschlussriegel	15.498H VR	35	30	80	37	63	St 142.30

**Zylinderrosetten für Fenstertüren**

Eisen verzinkt-altpatiniert

Bezeichnung	Bestellnummer	H	I	H	∅	CHF
RZ Rosette innen	15.493H I RZ	30	82	3	63	St 42.50
PZ Rosette innen	15.493H I PZ	30	82	3	63	St 42.50
Blindrosette aussen	15.493H A BL	30	82	3	63	St 42.50
RZ Rosette aussen	15.493H A RZ	30	82	3	63	St 42.50
PZ Rosette aussen	15.493H A PZ	30	82	3	63	St 42.50

**Zylinderrosetten für Fenstertüren**

Eisen verzinkt-altpatiniert

Bezeichnung	Bestellnummer	H	I	H	∅	CHF
RZ Rosette innen	15.495 I RZ	30	80	3	63	St 42.50
PZ Rosette innen	15.495 I PZ	30	80	3	63	St 42.50
Blindrosette aussen	15.495 A BL	30	80	3	63	St 42.50
RZ Rosette aussen	15.495 A RZ	30	80	3	63	St 42.50
PZ Rosette aussen	15.495 A PZ	30	80	3	63	St 42.50

**Zylinderrosetten für Fenstertüren**

Eisen verzinkt-altpatiniert

Bezeichnung	Bestellnummer	H	I	H	∅	CHF
RZ Rosette innen	15.498H I RZ	30	80	3	63	St 42.50
PZ Rosette innen	15.498H I PZ	30	80	3	63	St 42.50
Blindrosette aussen	15.498H A BL	30	80	3	63	St 42.50
RZ Rosette aussen	15.498H A RZ	30	80	3	63	St 42.50
PZ Rosette aussen	15.498H A PZ	30	80	3	63	St 42.50

**Gussvorreiber mit Streicher**

Eisen verzinkt-altpatiniert

Bezeichnung	Bestellnummer	H	I	H	≠	∅	CHF
Gussvorreiber mit Streicher	15.424	14	55	39	18	6	St 26.50

**Fensterknopf mit Rosette**

Eisen verzinkt-altpatiniert

Bezeichnung	Bestellnummer	H	I	H	∅	∅	CHF
Fensterknopf mit Rosette	15.445	25	25	77	30		St 53.00
Rosette	15.445 R		25	77	2	4.2 43	St 31.50

Fenstermittelband

Eisen verzinkt-altpatiniert

Bezeichnung	Bestellnummer	I	∅	≠	≠	▨	A	St	CHF
Fenstermittelband	15.402/190 M	190	7	18	20x3		45	St	55.50
Bolzenstützkloben	15.402 D1	125	7	18		M8x50		St	35.50
Bolzenstützkloben mit Platte 20x30mm	15.402 B1	125	7	18		M8x50		St	52.00



Fensterwinkelband

Eisen verzinkt-altpatiniert

Bezeichnung	Bestellnummer	I	∅	≠	≠	▨	A	St	CHF
Fensterwinkelband links	15.402/190 Ls	190	7	18	20x3		45	St	55.50
Fensterwinkelband rechts	15.402/190 Rs	190	7	18	20x3		45	St	55.50
Bolzenstützkloben	15.402 D1	125	7	18		M8x50		St	35.50
Bolzenstützkloben mit Platte 20x30mm	15.402 B1	125	7	18		M8x50		St	52.00



Jalousie-Langband

Eisen verzinkt-altpatiniert

Bezeichnung	Bestellnummer	H	I	i	∅	≠	A	St	CHF
Jalousie-Langband	15.500.1/250	250	47		11	4	65	St	75.00
Jalousie-Langband	15.500.1/300	300	47		11	4	65	St	76.00
Jalousie-Langband	15.500.1/350	350	47		11	4	65	St	78.00
Jalousie-Langband	15.500.1/400	400	47		11	4	65	St	81.00
Jalousie-Langband	15.500.1/450	450	47		11	4	65	St	85.00
Jalousie-Langband	15.500.1/500	500	47		11	4	65	St	90.00
Jalousie-Langband	15.500.1/550	550	47		11	4	65	St	97.00
Jalousie-Langband für Doppelladen	15.500.2/250	250	47	30	11	4	65	St	92.00
Jalousie-Langband für Doppelladen	15.500.2/300	300	47	30	11	4	65	St	94.00
Jalousie-Langband für Doppelladen	15.500.2/350	350	47	30	11	4	65	St	95.00
Jalousie-Langband für Doppelladen	15.500.2/400	400	47	30	11	4	65	St	99.00
Jalousie-Langband für Doppelladen	15.500.2/450	450	47	30	11	4	65	St	102.00
Jalousie-Langband für Doppelladen	15.500.2/500	500	47	30	11	4	65	St	106.00
Jalousie-Langband für Doppelladen	15.500.2/550	550	47	30	11	4	65	St	115.00

passende Kloben: siehe Art. 15.510 - 15.515



**Jalousie-Langband**

Eisen verzinkt-altpatiniert

Bezeichnung	Bestellnummer	H	I	i	Ø	≠	A	CHF
Jalousie-Langband	15.503.1/250	250	47		11	4	65	St 75.00
Jalousie-Langband	15.503.1/300	300	47		11	4	65	St 76.00
Jalousie-Langband	15.503.1/350	350	47		11	4	65	St 78.00
Jalousie-Langband	15.503.1/400	400	47		11	4	65	St 81.00
Jalousie-Langband	15.503.1/450	450	47		11	4	65	St 85.00
Jalousie-Langband	15.503.1/500	500	47		11	4	65	St 90.00
Jalousie-Langband	15.503.1/550	550	47		11	4	65	St 97.00
Jalousie-Langband für Doppelladen	15.503.2/400	400	47	30	11	4	65	St 99.00
Jalousie-Langband für Doppelladen	15.503.2/450	450	47	30	11	4	65	St 102.00
Jalousie-Langband für Doppelladen	15.503.2/500	500	47	30	11	4	65	St 106.00
Jalousie-Langband für Doppelladen	15.503.2/550	550	47	30	11	4	65	St 115.00

passende Kloben: siehe Art. 15.510 - 15.515

**Winkelband**

Eisen verzinkt-altpatiniert

Bezeichnung	Bestellnummer	H	I	i	Ø	≠	A	CHF
Winkelband links für Einfachladen	15.506.1 Ls	260	260		11	4	65	St 112.00
Winkelband rechts für Einfachladen	15.506.1 Rs	260	260		11	4	65	St 112.00
Winkelband links für Doppelladen	15.506.2 Ls	260	260	30	11	4	65	St 128.00
Winkelband rechts für Doppelladen	15.506.2 Rs	260	260	30	11	4	65	St 128.00

passende Kloben: siehe Art. 15.510 - 15.515

**Jalousie-Mittelband**

Eisen verzinkt-altpatiniert

Bezeichnung	Bestellnummer	H	I	i	Ø	A	CHF
Jalousie-Mittelband für Einfachladen	15.516.1	100	210		11	65	St 72.00
Jalousie-Mittelband für Doppelladen	15.516.2	100	210	30	11	65	St 89.00

passende Kloben: siehe Art. 15.510 - 15.515

Mittelbandscharnier

Eisen verzinkt-altpatiniert

Bezeichnung	Bestellnummer	H	I	∅	A	CHF
Mittelbandscharnier links	15.518 Ls	140	210	11	45	St 135.00
Mittelbandscharnier rechts	15.518 Rs	140	210	11	45	St 135.00

Abbildung = rechts

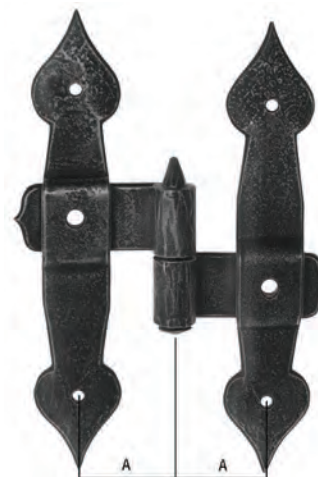

Bolzenkloben

Eisen verzinkt-altpatiniert

Bezeichnung	Bestellnummer	H	I	H	∅	≠	≡	CHF
Bolzenkloben für Einfachladen	15.514.1	24	77	100	11	16	M10	St 83.00
Bolzenkloben für Doppelladen	15.514.2	24	77	100	11		M10	St 83.00



Bolzenstützkloben

Eisen verzinkt-altpatiniert

Bezeichnung	Bestellnummer	H	I	H	∅	≠	CHF
Bolzenstützkloben für Einfachladen	15.515.1	24	185	110	11	16	St 93.00
Bolzenstützkloben für Doppelladen	15.515.2	24	185	110	11		St 93.00



Jalousie-Rückhalter

Eisen verzinkt-altpatiniert mit verstellbarem Anschlag

Bezeichnung	Bestellnummer	H	I	H	H	≡	CHF
Jalousie-Rückhalter	15.520.1	15	185	105	80	M10	St 98.00
Jalousie-Rückhalter für Doppelladen	15.520.2	15	185	155	80	M10	St 98.00



**Jalousie-Vorreiber**Eisen verzinkt-altpatiniert
mit verstellbarem Anschlag

Bezeichnung	Bestellnummer	H	I	H	H	mm	CHF
Jalousie-Vorreiber	15.524.1/70 mm	26	110	105	80	M10	St 89.00
Jalousie-Vorreiber für Doppelladen	15.524.2/115 mm	26	110	150	80	M10	St 89.00
Jalousie-Vorreiber für Aussenisolation	15.524.3/185 mm	26	110	220	80	M10	St 110.00

**Anziehschlengge**

Eisen verzinkt-altpatiniert

Bezeichnung	Bestellnummer	H	CHF
Anziehschlengge	15.551/050	50	St 62.00
Anziehschlengge	15.551/060	60	St 62.00
Anziehschlengge	15.551/070	70	St 62.00
Anziehschlengge	15.551/080	80	St 62.00
Anziehschlengge	15.551/090	90	St 62.00
Anziehschlengge	15.551/100	100	St 62.00
Anziehschlengge	15.551/110	110	St 62.00
Anziehschlengge	15.551/120	120	St 62.00
Anziehschlengge	15.551/130	130	St 62.00
Anziehschlengge	15.551/140	140	St 62.00
Anziehschlengge	15.551/150	150	St 62.00
Anziehschlengge	15.551/160	160	St 62.00
Anziehschlengge	15.551/170	170	St 62.00

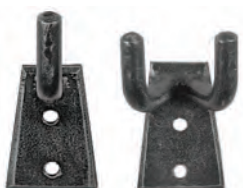
**Kloben**

Eisen verzinkt-altpatiniert

Bezeichnung	Bestellnummer	H	I	H	CHF
Winkelkloben	15.553	24	50	25	St 28.00
Gabelkloben	15.554	30	50	25	St 31.00

**Jalousie-Langband**

Eisen verzinkt-altpatiniert

Bezeichnung	Bestellnummer	H	I	I	Ø	≠	A	CHF
Jalousie-Langband	15.502.1/250	250	30		11	4	75	St 24.50
Jalousie-Langband	15.502.1/300	300	30		11	4	75	St 26.50
Jalousie-Langband	15.502.1/350	350	30		11	4	75	St 29.00
Jalousie-Langband	15.502.1/400	400	30		11	4	75	St 31.00
Jalousie-Langband	15.502.1/450	450	30		11	4	75	St 34.00
Jalousie-Langband	15.502.1/500	500	30		11	4	75	St 36.50
Jalousie-Langband	15.502.1/550	550	30		11	4	75	St 39.00
Jalousie-Langband für Doppelladen	15.502.2/250	250	30	30	11	4	75	St 32.00
Jalousie-Langband für Doppelladen	15.502.2/300	300	30	30	11	4	75	St 35.50
Jalousie-Langband für Doppelladen	15.502.2/350	350	30	30	11	4	75	St 38.50
Jalousie-Langband für Doppelladen	15.502.2/400	400	30	30	11	4	75	St 41.50
Jalousie-Langband für Doppelladen	15.502.2/450	450	30	30	11	4	75	St 44.00
Jalousie-Langband für Doppelladen	15.502.2/500	500	30	30	11	4	75	St 47.50
Jalousie-Langband für Doppelladen	15.502.2/550	550	30	30	11	4	75	St 50.50

passende Kloben: siehe Art. 15.510 - 15.513

Winkelbänder

Eisen verzinkt-altpatiniert

Bezeichnung	Bestellnummer	H	I	i	Ø	≠	A		CHF
Winkelbänder für Einfachladen	15.507.1 Pr	260	180		11	3	65	Pr	48.00
Winkelbänder für Doppelladen	15.507.2 Pr	260	180	30	11	3	65	Pr	59.00

passende Kloben: siehe Art. 15.510 - 15.513



Jalousie-Mittelband

Eisen verzinkt-altpatiniert

Bezeichnung	Bestellnummer	H	I	i	Ø	A		CHF
Jalousie-Mittelband für Einfachladen	15.517.1	95	130		11	65	St	18.50
Jalousie-Mittelband für Doppelladen	15.517.2	95	130	30	11	65	St	21.50

passende Kloben: siehe Art. 15.510 - 15.513



Mittelbandscharnier

Eisen verzinkt-altpatiniert

Bezeichnung	Bestellnummer	H	I	Ø	A		CHF
Mittelbandscharnier links	15.519 Ls	140	160	11	45	St	52.00
Mittelbandscharnier rechts	15.519 Rs	140	160	11	45	St	52.00



Aufschraubkloben

Eisen verzinkt-altpatiniert

Bezeichnung	Bestellnummer	H	I	i	Ø	≠		CHF
Aufschraubkloben für Einfachladen bündig	15.510 A1/12	35	100	12	11	0	St	19.00
Aufschraubkloben für Einfachladen	15.510 A2/23	35	100	23	11	16	St	19.00
Aufschraubkloben für Doppelladen	15.510 A3/35	35	100	35	11		St	20.50
Aufschraubkloben für Doppelladen	15.510 A4/40	35	100	40	11		St	21.00
Aufschraubkloben für Doppelladen	15.510 A5/45	35	100	45	11		St	21.50
Aufschraubkloben für Doppelladen	15.510 A6/50	35	100	50	11		St	22.00



**Dübelkloben**

Eisen verzinkt-altpatiniert

Bezeichnung	Bestellnummer	H	I	H	∅		CHF
Dübelkloben mit Holzgewinde	15.512/085	18	52	85	11		St 14.50
Dübelkloben mit Metallgewinde	15.513/085	18	52	85	11	M10	St 14.50
Dübelkloben mit Metallgewinde	15.513/110	18	52	110	11	M10	St 15.00

**Aufschraubplatte**

Eisen verzinkt-altpatiniert

Bezeichnung	Bestellnummer	H	≠		CHF
Aufschraubplatte	15.522 A	50	4	M10	St 10.50

**Jalousie-Rückhalter mit Metallgewinde**

Eisen verzinkt-altpatiniert

Bezeichnung	Bestellnummer	H	I	H	H		CHF
Jalousie-Rückhalter mit Gewinde M10	15.533.1	28	75	85	150	M10	St 50.00
Jalousie-Rückhalter Doppelladen/Gewinde M10	15.533.2	28	75	125	200	M10	St 52.00
Jalousie-Rückhalter Gewinde M10x250	15.533.3	28	75	125	250	M10	St 54.00

**Jalousie-Rückhalter mit Holzgewinde**

Eisen verzinkt-altpatiniert

Bezeichnung	Bestellnummer	H	I	H	H	CHF
Jalousie-Rückhalter mit Holzgewinde	15.534.1	28	75	85	100	St 50.00
Jalousie-Rückhalter Doppelladen/Holzgewinde	15.534.2	28	75	125	100	St 52.00

**Anziehschlenge einstellbar**

Eisen verzinkt-altpatiniert

Bezeichnung	Bestellnummer		CHF
Anziehschlenge einstellbar	15.550/160-250	4	St 22.00
Anziehschlenge einstellbar	15.550/250-370	4	St 27.00

**Anziehschlenge**

Eisen verzinkt-altpatiniert

Bezeichnung	Bestellnummer	H	CHF
Anziehschlenge	15.552/040	40	St 8.50
Anziehschlenge	15.552/060	60	St 9.00
Anziehschlenge	15.552/080	80	St 9.00
Anziehschlenge	15.552/100	100	St 9.00
Anziehschlenge	15.552/120	120	St 11.50
Anziehschlenge	15.552/140	140	St 12.00
Anziehschlenge	15.552/160	160	St 12.00

**Winkelschraube**

Eisen verzinkt-altpatiniert

Bezeichnung	Bestellnummer	H	CHF
Winkelschraube	15.555	55	St 9.00

Winkelkloben

Eisen verzinkt-altpatiniert

Bezeichnung	Bestellnummer	H	I	H	CHF
Winkelkloben	15.556 K1	14	50	28	St 10.00



Gabelkloben

Eisen verzinkt-altpatiniert

Bezeichnung	Bestellnummer	H	I	H	CHF
Gabelkloben	15.557 K2	34	55	28	St 10.00



Jalousiesperrstange

Eisen verzinkt-altpatiniert

Bezeichnung	Bestellnummer	H	CHF
Jalousiesperrstange	15.560/200	200	St 16.00
Jalousiesperrstange	15.560/250	250	St 16.00
Jalousiesperrstange	15.560/300	300	St 16.50
Jalousiesperrstange	15.560/350	350	St 17.00
Jalousiesperrstange	15.560/400	400	St 17.50
Jalousiesperrstange	15.560/500	500	St 20.50



Jalusierechen

Eisen verzinkt-altpatiniert

Bezeichnung	Bestellnummer	H	CHF
Jalusierechen	15.561/200	200	St 12.00
Jalusierechen	15.561/250	250	St 12.50
Jalusierechen	15.561/300	300	St 13.50
Jalusierechen	15.561/350	350	St 15.00
Jalusierechen	15.561/400	400	St 15.50
Jalusierechen	15.561/500	500	St 17.00



Jalousiehandgriff

Eisen verzinkt-altpatiniert

Bezeichnung	Bestellnummer	H	I	H	Ø	CHF
Jalousiehandgriff	15.562	170	14	45	8	St 13.50



Jalousiehandgriff

Eisen verzinkt-altpatiniert

Bezeichnung	Bestellnummer	H	I	H	Ø	CHF
Jalousiehandgriff	15.563	120	48	14	7	St 23.00



Jalusiesscharnier

Eisen verzinkt-altpatiniert
mit Ausziehdom

Bezeichnung	Bestellnummer	H	I	Ø	CHF
Jalusiesscharnier	15.564	91	90	11	St 23.50



4

**Jalousievorlegeriegel**

Eisen verzinkt-altpatiniert

Bezeichnung	Bestellnummer	H	I	H	CHF
Jalousievorlegeriegel	15.565	125	55	29	St 30.50

Anschlagwinkel

Eisen verzinkt-altpatiniert

Bezeichnung	Bestellnummer	H	I	H	CHF
Anschlagwinkel	15.568	30	20	20	St 9.50

Verschlussriegel

Eisen gerostet

Bezeichnung	Bestellnummer						CHF
Verschlussriegel	16.495 VR	35	30	80	37	63	St 145.30





Verschlussriegel

Eisen gerostet

Bezeichnung	Bestellnummer						CHF
Verschlussriegel	16.498H VR	35	30	80	37	63	St 145.30





Zylinderrosetten für Fenstertüren

Eisen gerostet

Bezeichnung	Bestellnummer					CHF
RZ Rosette innen	16.493H I RZ	30	82	3	63	St 43.00
PZ Rosette innen	16.493H I PZ	30	82	3	63	St 43.00





Zylinderrosetten für Fenstertüren

Eisen gerostet

Bezeichnung	Bestellnummer					CHF
RZ Rosette innen	16.495 I RZ	30	80	3	63	St 43.00
PZ Rosette innen	16.495 I PZ	30	80	3	63	St 43.00

Zylinderrosetten für Fenstertüren

Eisen gerostet

Bezeichnung	Bestellnummer					CHF
RZ Rosette innen	16.498H I RZ	30	80	3	63	St 43.00
PZ Rosette innen	16.498H I PZ	30	80	3	63	St 43.00





Gussvorreiber mit Streicher

Eisen gerostet

Bezeichnung	Bestellnummer						CHF
Gussvorreiber mit Streicher	16.424	14	55	39	18	6	St 28.50

Fensterknopf mit Rosette

Eisen gerostet

Bezeichnung	Bestellnummer						CHF
Fensterknopf mit Rosette	16.441	25	20	90	29	∅	St 51.00
Rosette	16.441 R		20	90	2	4.2	St 19.50



**Fenstermittelband**

Eisen gerostet

Bezeichnung	Bestellnummer	I	Ø	≠	≠	▨	A	CHF
Fenstermittelband	16.402/190 M	190	7	18	20x3		45	St 61.50
Bolzenstützkloben	16.402 D1	125	7	18		M8x50		St 39.00
Bolzenstützkloben mit Platte 20x30mm	16.402 B1	125	7	18		M8x50		St 55.50

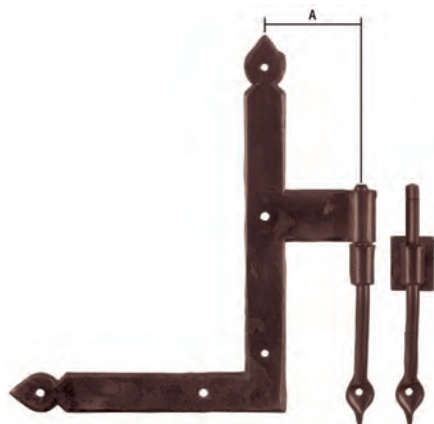
**Fensterwinkelband**

Eisen gerostet

Bezeichnung	Bestellnummer	I	Ø	≠	≠	▨	A	CHF
Fensterwinkelband links	16.402/190 Ls	190	7	18	20x3		45	St 61.50
Fensterwinkelband rechts	16.402/190 Rs	190	7	18	20x3		45	St 61.50
Bolzenstützkloben	16.402 D1	125	7	18		M8x50		St 39.00
Bolzenstützkloben mit Platte 20x30mm	16.402 B1	125	7	18		M8x50		St 55.50

**Gussvorreiber mit Streicher**

Eisen blank

Bezeichnung	Bestellnummer	H	I	H	≠	▨	CHF
Gussvorreiber mit Streicher	18.424	14	55	39	18	6	St 17.50

Eisen naturblank
Eisen verzinkt-allpatiniert
Eisen gerostet

Seite 5.02
Seite 5.16
Seite 5.22

Zierhülsen



Eisen naturblank
Eisen verzinkt-allpatiniert
Eisen gerostet

Seite 5.04
Seite 5.18
Seite 5.24

Einbohrbänder



Eisen naturblank
Eisen gerostet

Seite 5.05
Seite 5.24

Fischbänder



Eisen naturblank
Eisen verzinkt-allpatiniert
Eisen gerostet

Seite 5.07
Seite 5.19
Seite 5.25

Türkreuzbänder



Eisen naturblank
Eisen verzinkt-allpatiniert
Eisen gerostet

Seite 5.13
Seite 5.20
Seite 5.26

Türlängbänder und Kloben



**Hülsen für Einbohrbänder**

Eisen naturblank

Modell B

Bezeichnung	Bestellnummer	l	CHF
Hülsen für Einbohrbänder	13.1465/11	110	Pr 22.50
Hülsen für Einbohrbänder	13.1465/13	114	Pr 23.00
Hülsen für Einbohrbänder	13.1465/14.5	122	Pr 23.50
Hülsen für Einbohrbänder	13.1465/16	130	Pr 26.00
Hülsen für Einbohrbänder	13.1465/18	136	Pr 31.00

**Hülsen für Einbohrbänder**

Eisen naturblank

Modell B

Bezeichnung	Bestellnummer	l	CHF
Hülsen für Einbohrbänder	13.1470/13	54	Pr 22.00
Hülsen für Einbohrbänder	13.1470/14.5	56	Pr 20.00
Hülsen für Einbohrbänder	13.1470/16	60	Pr 21.00
Hülsen für Einbohrbänder	13.1470/18	56	Pr 24.50

**Hülsen für Einbohrbänder**

Eisen naturblank

Modell B

Bezeichnung	Bestellnummer	l	CHF
Hülsen für Einbohrbänder	13.1475/11	102	Pr 23.00
Hülsen für Einbohrbänder	13.1475/13	110	Pr 20.00
Hülsen für Einbohrbänder	13.1475/14.5	112	Pr 20.50
Hülsen für Einbohrbänder	13.1475/16	122	Pr 24.50
Hülsen für Einbohrbänder	13.1475/18	120	Pr 29.00

**Hülsen für Einbohrbänder**

Eisen naturblank

Modell C

Bezeichnung	Bestellnummer	l	CHF
Hülsen für Einbohrbänder	13.1466 C/13	122.5	Gt 33.10
Hülsen für Einbohrbänder	13.1466 C/14.5	127	Gt 33.80
Hülsen für Einbohrbänder	13.1466 C/16	146	Gt 36.50
Hülsen für Einbohrbänder	13.1466 C/18	154	Gt 42.50

**Hülsen für Einbohrbänder**

Eisen naturblank

Modell C

Bezeichnung	Bestellnummer	l	CHF
Hülsen für Einbohrbänder	13.1471 C/13	67	Gt 32.10
Hülsen für Einbohrbänder	13.1471 C/14.5	59	Gt 30.30
Hülsen für Einbohrbänder	13.1471 C/16	76	Gt 31.50
Hülsen für Einbohrbänder	13.1471 C/18	74	Gt 36.00

**Hülsen für Einbohrbänder**

Eisen naturblank

Modell C

Bezeichnung	Bestellnummer	l	CHF
Hülsen für Einbohrbänder	13.1476 C/13	122.5	Gt 30.10
Hülsen für Einbohrbänder	13.1476 C/14.5	125	Gt 30.80
Hülsen für Einbohrbänder	13.1476 C/16	138	Gt 35.00
Hülsen für Einbohrbänder	13.1476 C/18	138	Gt 40.50

Hülsen für Einbohrbänder

Eisen naturblank
Modell HR+HF

Bezeichnung	Bestellnummer	l		CHF
Hülsen für Einbohrbänder	13.1466 HR/18	161.5	Gt	43.00
Hülsen für Einbohrbänder	13.1466 HR/20	179.5	Gt	50.50
Hülsen für Einbohrbänder	13.1466 HR/22	194.5	Gt	56.00

Hülsen für Einbohrbänder

Eisen naturblank
Modell HR+HF

Bezeichnung	Bestellnummer	l		CHF
Hülsen für Einbohrbänder	13.1471 HR/18	81.5	Gt	36.50
Hülsen für Einbohrbänder	13.1471 HR/20	85.5	Gt	50.50
Hülsen für Einbohrbänder	13.1471 HR/22	92.5	Gt	57.00

Hülsen für Einbohrbänder

Eisen naturblank
Modell HR+HF

Bezeichnung	Bestellnummer	l		CHF
Hülsen für Einbohrbänder	13.1476 HR/18	145.5	Gt	41.00
Hülsen für Einbohrbänder	13.1476 HR/20	151.5	Gt	53.50
Hülsen für Einbohrbänder	13.1476 HR/22	162.5	Gt	60.00

Hülsen für 3D-Bänder

Eisen naturblank
zu ANUBA Triplex

Bezeichnung	Bestellnummer	l		CHF
Hülsen für 3D-Bänder	13.1468/17	226	Pr	43.00
Hülsen für 3D-Bänder	13.1468/20	242	Pr	49.00

Hülsen für 3D-Bänder

Eisen naturblank
zu SASSBA 11R+12R

Bezeichnung	Bestellnummer	l		CHF
Hülsen für 3D-Bänder	13.1473/15	132	Pr	41.00
Hülsen für 3D-Bänder	13.1473/20	132	Pr	47.00



**Hülsen für 3D-Bänder**Eisen naturblank
zu ANUBA Triplex

Bezeichnung	Bestellnummer	I	CHF
Hülsen für 3D-Bänder	13.1474/17	150	Pr 43.00
Hülsen für 3D-Bänder	13.1474/20	152	Pr 49.00

**Hülsen für 3D-Bänder**Eisen naturblank
zu SASSBA 11R+12R

Bezeichnung	Bestellnummer	I	CHF
Hülsen für 3D-Bänder	13.1478/15	198	Pr 41.00
Hülsen für 3D-Bänder	13.1478/20	198	Pr 47.00

**Hülsen für 3D-Bänder**Eisen naturblank
zu ANUBA Triplex

Bezeichnung	Bestellnummer	I	CHF
Hülsen für 3D-Bänder	13.1479/17	210	Pr 43.00
Hülsen für 3D-Bänder	13.1479/20	220	Pr 49.00

**Einbohrband**Eisen naturblank
Modell B

Bezeichnung	Bestellnummer	I	CHF
Einbohrband	13.1482/11	31 27/27	St 13.00
Einbohrband	13.1482/13	35 36/36	St 13.50
Einbohrband	13.1482/14	40 44/44	St 16.00
Einbohrband	13.1482/16 R	45 44/52	St 18.00
Einbohrband	13.1482/18 R	44 44/61	St 22.00

**Einbohrband**Eisen naturblank
Modell B

Bezeichnung	Bestellnummer	I	CHF
Einbohrband	13.1486/09	65 23/23	St 13.00
Einbohrband	13.1486/11	80 27/27	St 14.00
Einbohrband	13.1486/13	88 36/36	St 15.00
Einbohrband	13.1486/14	93 44/44	St 16.00
Einbohrband	13.1486/16 R	108 44/52	St 19.00

Einbohrband

Eisen naturblank
Modell C

Bezeichnung	Bestellnummer	∏	mm	CHF
Einbohrband	13.1488/14.5	41	31/40	St 24.00
Einbohrband	13.1488/16 R	47	40/55	St 26.00
Einbohrband	13.1488/18 R	49	40/60	St 30.00
Einbohrband	13.1488/18 F	49	60/60	St 30.00

Einbohrband

Eisen naturblank
Modell HR

Bezeichnung	Bestellnummer	∏	mm	CHF
Einbohrband	13.1489 HR/20	64	44/60	St 31.00
Einbohrband	13.1489 HR/22	71	55/75	St 35.00

Fischband

Eisen naturblank
Lappen seitlich

Bezeichnung	Bestellnummer	H	∏	∅	CHF
Fischband links	13.1176/120 Ls	70	132	12	St 23.00
Fischband rechts	13.1176/120 Rs	70	132	12	St 23.00
Fischband links	13.1176/140 Ls	80	154	13	St 27.00
Fischband rechts	13.1176/140 Rs	80	154	13	St 27.00

Fischband

Eisen naturblank
Lappen mittig

Bezeichnung	Bestellnummer	H	∏	∅	CHF
Fischband/Lappen mittig	13.1177/120	70	133	12	St 23.00
Fischband/Lappen mittig	13.1177/140	80	155	13	St 27.00

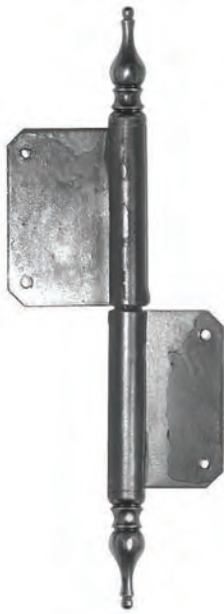

**Fischband**Eisen naturblank
Lappen seitlich

Bezeichnung	Bestellnummer	H	I	Ø		CHF
Fischband links	13.1178/060 Ls	45	105	8	St	19.00
Fischband rechts	13.1178/060 Rs	45	105	8	St	19.00
Fischband links	13.1178/080 Ls	50	132	9	St	22.00
Fischband rechts	13.1178/080 Rs	50	132	9	St	22.00
Fischband links	13.1178/100 Ls	60	162	10	St	22.50
Fischband rechts	13.1178/100 Rs	60	162	10	St	22.50
Fischband links	13.1178/120 Ls	70	195	12	St	23.00
Fischband rechts	13.1178/120 Rs	70	195	12	St	23.00

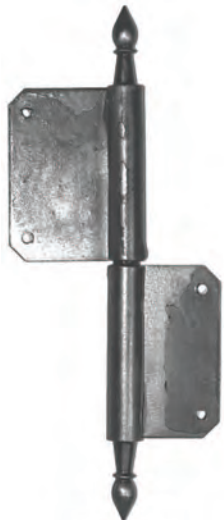
**Fischband**Eisen naturblank
Lappen seitlich

Bezeichnung	Bestellnummer	H	I	Ø		CHF
Fischband links	13.1180/060 Ls	45	95	8	St	19.00
Fischband rechts	13.1180/060 Rs	45	95	8	St	19.00
Fischband links	13.1180/080 Ls	50	120	9	St	22.00
Fischband rechts	13.1180/080 Rs	50	120	9	St	22.00
Fischband links	13.1180/100 Ls	60	150	10	St	22.50
Fischband rechts	13.1180/100 Rs	60	150	10	St	22.50
Fischband links	13.1180/120 Ls	70	180	12	St	23.00
Fischband rechts	13.1180/120 Rs	70	180	12	St	23.00
Fischband links	13.1180/140 Ls	80	205	13	St	27.00
Fischband rechts	13.1180/140 Rs	80	205	13	St	27.00
Fischband links	13.1180/160 Ls	95	230	14	St	31.00
Fischband rechts	13.1180/160 Rs	95	230	14	St	31.00
Fischband links	13.1180/180 Ls	105	260	16	St	37.50
Fischband rechts	13.1180/180 Rs	105	260	16	St	37.50

**Fischband**Eisen naturblank
Lappen mittig

Bezeichnung	Bestellnummer	H	I	Ø		CHF
Fischband/Lappen mittig	13.1181/060	45	95	8	St	19.00
Fischband/Lappen mittig	13.1181/080	50	120	9	St	22.00
Fischband/Lappen mittig	13.1181/100	60	150	10	St	22.50
Fischband/Lappen mittig	13.1181/120	70	180	12	St	23.00
Fischband/Lappen mittig	13.1181/140	80	200	13	St	27.00
Fischband/Lappen mittig	13.1181/160	95	230	14	St	31.00

Türband

Eisen naturblank

Bezeichnung	Bestellnummer	H	I	H	Ø	≠	St	CHF
Türband ohne Kloben	13.301/215	160	215	5	12		St	98.50
Plattenkloben	13.301 A2	30	110	41	12	18	St	83.50

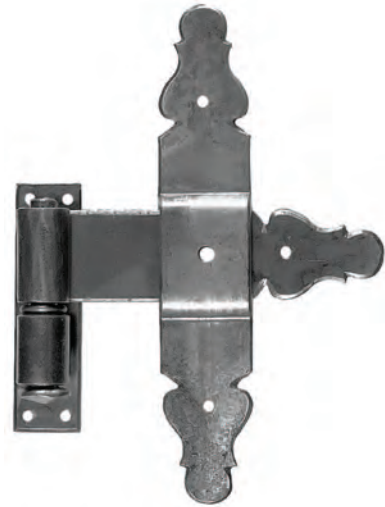

Türband

Eisen naturblank

Bezeichnung	Bestellnummer	H	I	I _R	H	Ø	≠	St	CHF
Türband ohne Kloben	13.304/270	120	270		6	12		St	86.50
Plattenstützkloben	13.304 B2	30	187	115	47	12	18	St	83.50



**Türband**

Eisen naturblank

Bezeichnung	Bestellnummer	H	I	TR	H	Ø	≠	CHF
Türband ohne Kloben	13.305/255	140	255		5	12		St 111.50
Plattenstützkloben	13.305 B2	30	165	80	41	12	18	St 78.50
Bolzenstützkloben	13.305 D2	21	175		40	12	18	St 71.00

**Türband**

Eisen naturblank

Bezeichnung	Bestellnummer	H	I	TR	H	Ø	≠	CHF
Türband ohne Kloben	13.306/290	145	290		6	15		St 133.00
Plattenstützkloben	13.332 B2	40	225	123	52	15	18	St 126.00
Bolzenstützkloben	13.332 D2	30	225		54	15	18	St 92.50

Türband

Eisen naturblank

Bezeichnung	Bestellnummer	H	I	H	Ø	≠	CHF
Türband mit Kloben	13.308/365 D2	170	365	46	12	18	St 424.50



Türband

Eisen naturblank

Bezeichnung	Bestellnummer	H	I	H	Ø	≠	CHF
Türband mit Kloben	13.315/425 B2	165	425	38	15	18	St 375.00



**Türband**

Eisen naturblank

Bezeichnung	Bestellnummer	H	I	H	Ø	≠	CHF
Türband mit Kloben	13.316/430 D2	225	430	52	15	18	St 473.00

**Türband**

Eisen naturblank

Bezeichnung	Bestellnummer	H	I	H	Ø	≠	CHF
Türband mit Kloben	13.320/470 D2	200	470	50	15	18	St 664.50

Türband

Eisen naturblank

Bezeichnung	Bestellnummer	H	I	H	Ø	≠	CHF
Türband ohne Kloben	13.324/240	146	240	6	12		St 109.00
Plattenkloben	13.324 A2	30	106	41	12	18	St 85.50



Türband

Eisen naturblank

Bezeichnung	Bestellnummer	H	I	I _R	H	Ø	≠	CHF
Türband ohne Kloben	13.325/250	140	250		6	12		St 109.00
Plattenstützkloben	13.325 B2	30	150	80	46	12	18	St 98.50
Bolzenstützkloben	13.325 D2	29	150		46	12	18	St 74.00

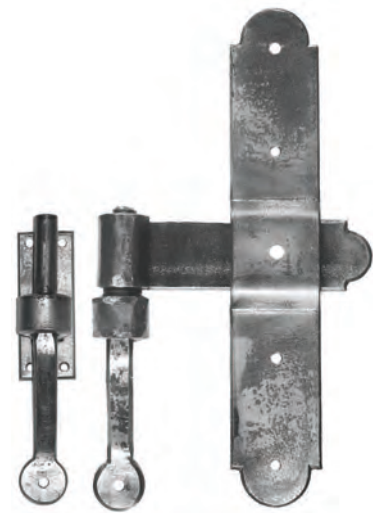

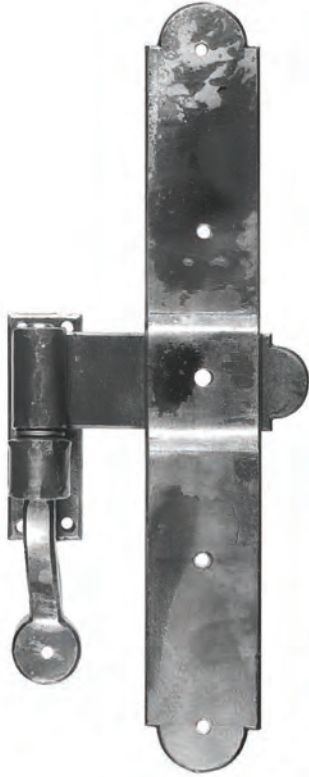
**Türband**

Eisen naturblank

Bezeichnung	Bestellnummer	H	I	R	H	Ø	≠	CHF
Türband ohne Kloben	13.327/400	160	400		6	15		St 158.00
Plattenstützkloben	13.327 B2	40	215	123	48	15	18	St 117.50

**Türband**

Eisen naturblank

Bezeichnung	Bestellnummer	H	I	H	Ø	≠	CHF
Türband mit Kloben	13.328/295 D2	170	295	45	12	18	St 190.50

Kloben

Eisen naturblank

Bezeichnung	Bestellnummer	H	I	TR	H	Ø	≠	CHF
Plattenkloben	13.332 A1	40	123		37	15	11	St 92.50
Plattenkloben	13.332 A2	40	123		46	15	18	St 92.50
Plattenkloben	13.332 A3	40	123		58	15	30	St 92.50
Plattenstützkloben	13.332 B1	40	225	123	46	15	11	St 126.00
Plattenstützkloben	13.332 B2	40	225	123	52	15	18	St 126.00
Plattenstützkloben	13.332 B3	40	225	123	62	15	30	St 126.00

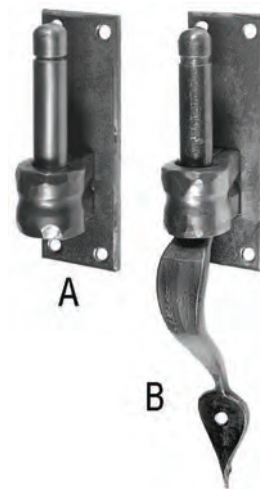

Kloben

Eisen naturblank

Bezeichnung	Bestellnummer	H	I	H	Ø	≠	CHF
Bolzenkloben	13.332 C2	30	93	45	15	18	St 86.50
Bolzenstützkloben	13.332 D2	30	225	54	15	18	St 92.50

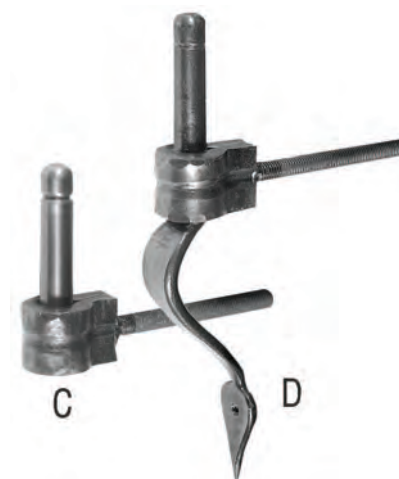

Türlangband

Eisen naturblank

Bezeichnung	Bestellnummer	H	I	H	Ø	A	CHF
Türlangband	13.332/350	365	70	6	15	90	St 94.50
Türlangband	13.332/500	515	70	6	15	90	St 94.50
Türlangband	13.332/600	615	70	6	15	90	St 112.50
Türlangband	13.332/700	715	70	6	15	90	St 146.50
Türlangband	13.332/800	815	70	6	15	90	St 174.50
Türlangband	13.332/900	915	70	6	15	90	St 212.00

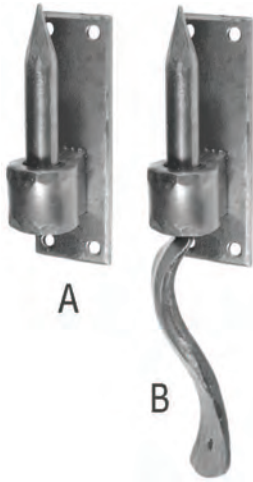

passende Kloben: siehe Art. 13.332

**Kloben**

Eisen naturblank

Bezeichnung	Bestellnummer	H	I	\bar{I} R	H	Ø	≠	CHF
Plattenkloben	13.333 A1	40	120		36	15	11	St 92.50
Plattenkloben	13.333 A2	40	120		45	15	18	St 92.50
Plattenstützkloben	13.333 B1	40	250	118	36	15	11	St 126.00
Plattenstützkloben	13.333 B2	40	250	118	45	15	18	St 126.00

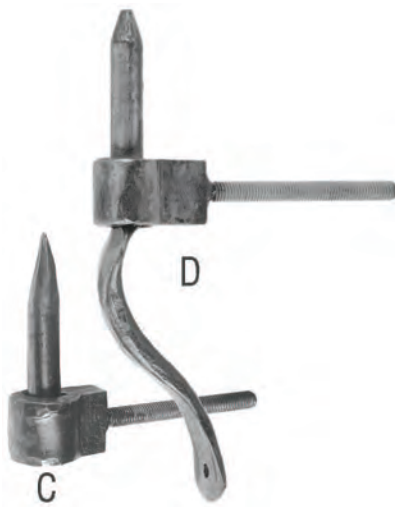
**Kloben**

Eisen naturblank

Bezeichnung	Bestellnummer	H	I	H	Ø	≠	CHF
Bolzenkloben	13.333 C2	30	100	45	15	18	St 86.50
Bolzenstützkloben	13.333 D2	30	250	50	15	18	St 92.50

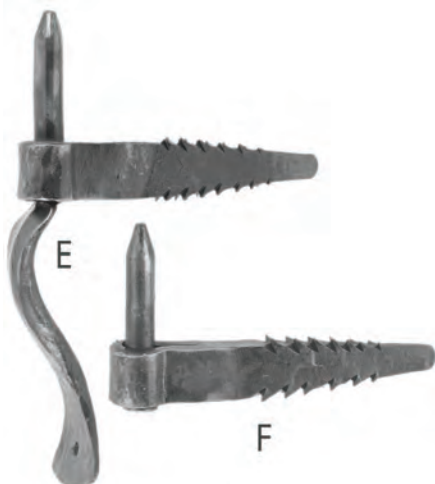
**Kloben**

Eisen naturblank

Bezeichnung	Bestellnummer	H	I	H	Ø	≠	CHF
Stützkloben zum Einschlagen	13.333 E	33	250	45	15	18	St 108.00
Bolzenkloben zum Einschlagen	13.333 F	30	100	45	15	18	St 95.50

Türlangband

Eisen naturblank

Bezeichnung	Bestellnummer	H	I	H	Ø	A	CHF
Türlangband	13.333/350	365	70	6	15	90	St 94.50
Türlangband	13.333/500	515	70	6	15	90	St 94.50
Türlangband	13.333/600	615	70	6	15	90	St 112.50
Türlangband	13.333/700	715	70	6	15	90	St 146.50
Türlangband	13.333/800	815	70	6	15	90	St 174.50
Türlangband	13.333/900	915	70	6	15	90	St 212.00

passende Kloben: siehe Art. 13.333



Türmittelband

Eisen naturblank

Bezeichnung	Bestellnummer	H	I	H	Ø	A	CHF
Türmittelband	13.334 M	155	270	6	15	100	St 159.00

passende Kloben: siehe Art. 13.332



Türwinkelband

Eisen naturblank

Bezeichnung	Bestellnummer	H	I	H	Ø	CHF
Türwinkelband links	13.334/600 Ls	705	450	6	15	St 240.00
Türwinkelband rechts	13.334/600 Rs	705	450	6	15	St 240.00
Türwinkelband links	13.334/700 Ls	805	450	6	15	St 257.00
Türwinkelband rechts	13.334/700 Rs	805	450	6	15	St 257.00
Türwinkelband links	13.334/800 Ls	905	450	6	15	St 291.00
Türwinkelband rechts	13.334/800 Rs	905	450	6	15	St 291.00

passende Kloben: siehe Art. 13.332



**Hülsen für Einbohrbänder**Eisen verzinkt-altpatiniert
Modell B

Bezeichnung	Bestellnummer	I	CHF
Hülsen für Einbohrbänder	15.1470/13	54	Pr 33.00
Hülsen für Einbohrbänder	15.1470/14.5	56	Pr 31.00
Hülsen für Einbohrbänder	15.1470/16	60	Pr 32.00
Hülsen für Einbohrbänder	15.1470/18	56	Pr 35.50

**Hülsen für Einbohrbänder**Eisen verzinkt-altpatiniert
Modell B

Bezeichnung	Bestellnummer	I	CHF
Hülsen für Einbohrbänder	15.1475/13	110	Pr 31.00
Hülsen für Einbohrbänder	15.1475/14.5	112	Pr 31.50
Hülsen für Einbohrbänder	15.1475/16	122	Pr 35.50
Hülsen für Einbohrbänder	15.1475/18	120	Pr 40.00

**Hülsen für Einbohrbänder**Eisen verzinkt-altpatiniert
Modell C

Bezeichnung	Bestellnummer	I	CHF
Hülsen für Einbohrbänder	15.1471 C/13	67	Gt 48.60
Hülsen für Einbohrbänder	15.1471 C/14.5	59	Gt 46.80
Hülsen für Einbohrbänder	15.1471 C/16	76	Gt 48.00
Hülsen für Einbohrbänder	15.1471 C/18	74	Gt 52.50

**Hülsen für Einbohrbänder**Eisen verzinkt-altpatiniert
Modell C

Bezeichnung	Bestellnummer	I	CHF
Hülsen für Einbohrbänder	15.1476 C/13	122.5	Gt 46.60
Hülsen für Einbohrbänder	15.1476 C/14.5	125	Gt 47.30
Hülsen für Einbohrbänder	15.1476 C/16	138	Gt 51.50
Hülsen für Einbohrbänder	15.1476 C/18	138	Gt 57.00

**Hülsen für Einbohrbänder**Eisen verzinkt-altpatiniert
Modell HR+HF

Bezeichnung	Bestellnummer	I	CHF
Hülsen für Einbohrbänder	15.1471 HR/18	81.5	Gt 53.00
Hülsen für Einbohrbänder	15.1471 HR/20	85.5	Gt 67.00
Hülsen für Einbohrbänder	15.1471 HR/22	92.5	Gt 73.50

**Hülsen für Einbohrbänder**Eisen verzinkt-altpatiniert
Modell HR+HF

Bezeichnung	Bestellnummer	I	CHF
Hülsen für Einbohrbänder	15.1476 HR/18	145.5	Gt 57.50
Hülsen für Einbohrbänder	15.1476 HR/20	151.5	Gt 70.00
Hülsen für Einbohrbänder	15.1476 HR/22	162.5	Gt 76.50

Hülsen für 3D-Bänder

Eisen verzinkt-altpatiniert
zu SASSBA 11R+12R

Bezeichnung	Bestellnummer	l	CHF
Hülsen für 3D-Bänder	15.1473/15	132	Pr 52.00
Hülsen für 3D-Bänder	15.1473/20	132	Pr 58.00



Hülsen für 3D-Bänder

Eisen verzinkt-altpatiniert
zu ANUBA Triplex

Bezeichnung	Bestellnummer	l	CHF
Hülsen für 3D-Bänder	15.1474/17	150	Pr 54.00
Hülsen für 3D-Bänder	15.1474/20	152	Pr 60.00



Hülsen für 3D-Bänder

Eisen verzinkt-altpatiniert
zu SASSBA 11R+12R

Bezeichnung	Bestellnummer	l	CHF
Hülsen für 3D-Bänder	15.1478/15	198	Pr 52.00
Hülsen für 3D-Bänder	15.1478/20	198	Pr 58.00



Hülsen für 3D-Bänder

Eisen verzinkt-altpatiniert
zu ANUBA Triplex

Bezeichnung	Bestellnummer	l	CHF
Hülsen für 3D-Bänder	15.1479/17	210	Pr 54.00
Hülsen für 3D-Bänder	15.1479/20	220	Pr 60.00



**Einbohrband**Eisen verzinkt-altpatiniert
Modell B

Bezeichnung	Bestellnummer	I	mm	CHF
Einbohrband	15.1482/11	31	27/27	St 18.50
Einbohrband	15.1482/13	35	36/36	St 19.00
Einbohrband	15.1482/14	40	44/44	St 21.50
Einbohrband	15.1482/16 R	45	44/52	St 23.50
Einbohrband	15.1482/18 R	44	44/61	St 27.50

**Einbohrband**Eisen verzinkt-altpatiniert
Modell B

Bezeichnung	Bestellnummer	I	mm	CHF
Einbohrband	15.1486/09	65	23/23	St 18.50
Einbohrband	15.1486/11	80	27/27	St 19.50
Einbohrband	15.1486/13	88	36/36	St 20.50
Einbohrband	15.1486/14	93	44/44	St 21.50
Einbohrband	15.1486/16 R	108	44/52	St 24.50

**Einbohrband**Eisen verzinkt-altpatiniert
Modell C

Bezeichnung	Bestellnummer	I	mm	CHF
Einbohrband	15.1488/14.5	41	31/40	St 31.50
Einbohrband	15.1488/18 R	49	40/60	St 37.50

Türband

Eisen verzinkt-altpatiniert

Bezeichnung	Bestellnummer	H	I	IR	H	Ø	≠	CHF
Türband ohne Kloben	15.305/255	140	255		5	12		St 129.50
Plattenstützkloben	15.305 B2	30	165	80	41	12	18	St 92.50
Bolzenstützkloben	15.305 D2	21	175		40	12	18	St 85.00



Türband

Eisen verzinkt-altpatiniert

Bezeichnung	Bestellnummer	H	I	H	Ø	≠	CHF
Türband ohne Kloben	15.324/240	146	240	6	12		St 127.00
Plattenkloben	15.324 A2	30	106	41	12	18	St 99.50



Türband

Eisen verzinkt-altpatiniert

Bezeichnung	Bestellnummer	H	I	IR	H	Ø	≠	CHF
Türband ohne Kloben	15.325/250	140	250		6	12		St 127.00
Plattenstützkloben	15.325 B2	30	150	80	46	12	18	St 112.50
Bolzenstützkloben	15.325 D2	29	150		46	12	18	St 88.00

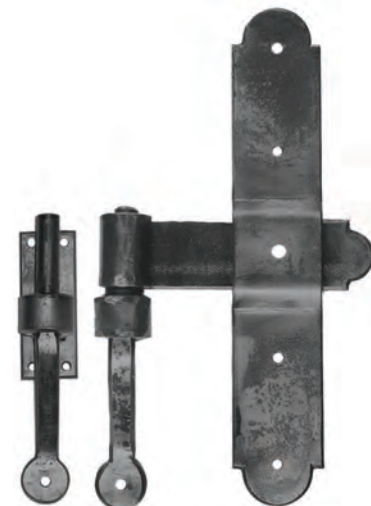

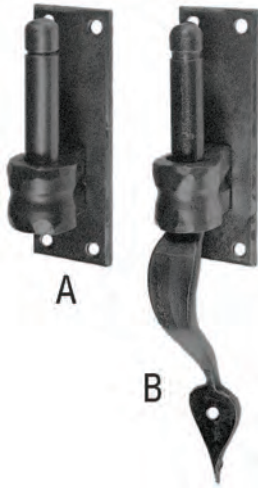
**Kloben**

Eisen verzinkt-altpatiniert

Bezeichnung	Bestellnummer	H	I	TR	H	Ø	≠	CHF
Plattenkloben	15.332 A1	40	123		37	15	11	St 107.50
Plattenkloben	15.332 A2	40	123		46	15	18	St 107.50
Plattenkloben	15.332 A3	40	123		58	15	30	St 107.50
Plattenstützkloben	15.332 B1	40	225	123	46	15	11	St 141.00
Plattenstützkloben	15.332 B2	40	225	123	52	15	18	St 141.00
Plattenstützkloben	15.332 B3	40	225	123	62	15	30	St 141.00

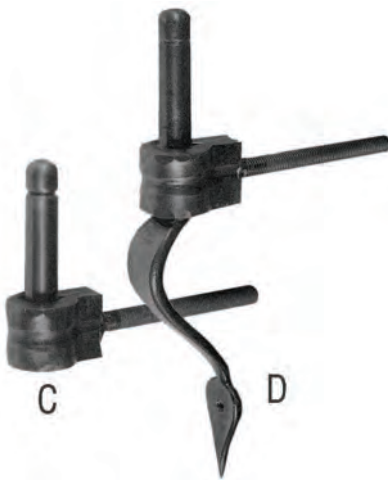
**Kloben**

Eisen verzinkt-altpatiniert

Bezeichnung	Bestellnummer	H	I	H	Ø	≠	CHF
Bolzenkloben	15.332 C2	30	93	45	15	18	St 96.50
Bolzenstützkloben	15.332 D2	30	225	54	15	18	St 107.50

**Türlangband**

Eisen verzinkt-altpatiniert

Bezeichnung	Bestellnummer	H	I	H	Ø	A	CHF
Türlangband	15.332/350	365	70	6	15	90	St 119.50
Türlangband	15.332/500	515	70	6	15	90	St 124.50
Türlangband	15.332/600	615	70	6	15	90	St 147.50
Türlangband	15.332/700	715	70	6	15	90	St 187.50
Türlangband	15.332/800	815	70	6	15	90	St 224.50
Türlangband	15.332/900	915	70	6	15	90	St 272.00

passende Kloben: siehe Art. 15.332

**Türlangband**

Eisen verzinkt-altpatiniert

Bezeichnung	Bestellnummer	H	I	H	Ø	A	CHF
Türlangband	15.333/350	365	70	6	15	90	St 119.50
Türlangband	15.333/500	515	70	6	15	90	St 124.50
Türlangband	15.333/600	615	70	6	15	90	St 147.50
Türlangband	15.333/700	715	70	6	15	90	St 187.50
Türlangband	15.333/800	815	70	6	15	90	St 224.50
Türlangband	15.333/900	915	70	6	15	90	St 272.00

passende Kloben: siehe Art. 15.332

Türmittelband

Eisen verzinkt-altpatiniert

Bezeichnung	Bestellnummer	H	I	H	Ø	A	CHF
Türmittelband	15.334 M	155	270	6	15	100	St 184.00

passende Kloben: siehe Art. 15.332



Türwinkelband

Eisen verzinkt-altpatiniert

Bezeichnung	Bestellnummer	H	I	H	Ø	CHF
Türwinkelband links	15.334/600 Ls	705	450	6	15	St 310.00
Türwinkelband rechts	15.334/600 Rs	705	450	6	15	St 310.00
Türwinkelband links	15.334/700 Ls	805	450	6	15	St 332.00
Türwinkelband rechts	15.334/700 Rs	805	450	6	15	St 332.00
Türwinkelband links	15.334/800 Ls	905	450	6	15	St 376.00
Türwinkelband rechts	15.334/800 Rs	905	450	6	15	St 376.00

passende Kloben: siehe Art. 15.332

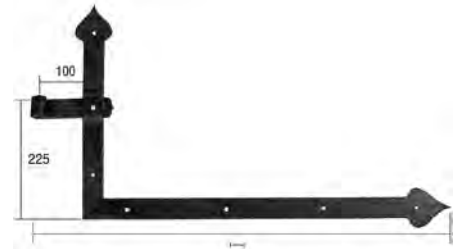

**Hülsen für Einbohrbänder**Eisen gerostet
Modell B

Bezeichnung	Bestellnummer	l		CHF
Hülsen für Einbohrbänder	16.1470/13	54	Pr	37.50
Hülsen für Einbohrbänder	16.1470/14.5	56	Pr	35.50
Hülsen für Einbohrbänder	16.1470/16	60	Pr	36.50
Hülsen für Einbohrbänder	16.1470/18	56	Pr	40.00

**Hülsen für Einbohrbänder**Eisen gerostet
Modell B

Bezeichnung	Bestellnummer	l		CHF
Hülsen für Einbohrbänder	16.1475/13	110	Pr	35.50
Hülsen für Einbohrbänder	16.1475/14.5	112	Pr	36.00
Hülsen für Einbohrbänder	16.1475/16	122	Pr	40.00
Hülsen für Einbohrbänder	16.1475/18	120	Pr	44.50

**Hülsen für Einbohrbänder**Eisen gerostet
Modell C

Bezeichnung	Bestellnummer	l		CHF
Hülsen für Einbohrbänder	16.1471 C/13	67	Gt	55.60
Hülsen für Einbohrbänder	16.1471 C/14.5	59	Gt	53.80
Hülsen für Einbohrbänder	16.1471 C/16	76	Gt	55.00
Hülsen für Einbohrbänder	16.1471 C/18	74	Gt	59.50

**Hülsen für Einbohrbänder**Eisen gerostet
Modell C

Bezeichnung	Bestellnummer	l		CHF
Hülsen für Einbohrbänder	16.1476 C/13	122.5	Gt	53.60
Hülsen für Einbohrbänder	16.1476 C/14.5	125	Gt	54.30
Hülsen für Einbohrbänder	16.1476 C/16	138	Gt	58.50
Hülsen für Einbohrbänder	16.1476 C/18	138	Gt	64.00

**Hülsen für Einbohrbänder**Eisen gerostet
Modell HR+HF

Bezeichnung	Bestellnummer	l		CHF
Hülsen für Einbohrbänder	16.1471 HR/18	81.5	Gt	60.00
Hülsen für Einbohrbänder	16.1471 HR/20	85.5	Gt	74.00
Hülsen für Einbohrbänder	16.1471 HR/22	92.5	Gt	80.50

**Hülsen für Einbohrbänder**Eisen gerostet
Modell HR+HF

Bezeichnung	Bestellnummer	l		CHF
Hülsen für Einbohrbänder	16.1476 HR/18	145.5	Gt	64.50
Hülsen für Einbohrbänder	16.1476 HR/20	151.5	Gt	77.00
Hülsen für Einbohrbänder	16.1476 HR/22	162.5	Gt	83.50

Hülsen für 3D-Bänder

Eisen gerostet
zu SASSBA 11R+12R

Bezeichnung	Bestellnummer	∏	CHF
Hülsen für 3D-Bänder	16.1473/15	132	Pr 56.50
Hülsen für 3D-Bänder	16.1473/20	132	Pr 62.50



Hülsen für 3D-Bänder

Eisen gerostet
zu ANUBA Triplex

Bezeichnung	Bestellnummer	∏	CHF
Hülsen für 3D-Bänder	16.1474/17	150	Pr 58.50
Hülsen für 3D-Bänder	16.1474/20	152	Pr 64.50



Hülsen für 3D-Bänder

Eisen gerostet
zu SASSBA 11R+12R

Bezeichnung	Bestellnummer	∏	CHF
Hülsen für 3D-Bänder	16.1478/15	198	Pr 56.50
Hülsen für 3D-Bänder	16.1478/20	198	Pr 62.50



Hülsen für 3D-Bänder

Eisen gerostet
zu ANUBA Triplex

Bezeichnung	Bestellnummer	∏	CHF
Hülsen für 3D-Bänder	16.1479/17	210	Pr 58.50
Hülsen für 3D-Bänder	16.1479/20	220	Pr 64.50



**Einbohrband**Eisen gerostet
Modell B

Bezeichnung	Bestellnummer	I	mm	CHF
Einbohrband	16.1482/11	31	27/27	St 21.00
Einbohrband	16.1482/13	35	36/36	St 21.50
Einbohrband	16.1482/14	40	44/44	St 24.00
Einbohrband	16.1482/16 R	45	44/52	St 26.00
Einbohrband	16.1482/18 R	44	44/61	St 30.00

**Einbohrband**Eisen gerostet
Modell B

Bezeichnung	Bestellnummer	I	mm	CHF
Einbohrband	16.1486/09	65	23/23	St 21.00
Einbohrband	16.1486/11	80	27/27	St 22.00
Einbohrband	16.1486/13	88	36/36	St 23.00
Einbohrband	16.1486/14	93	44/44	St 24.00
Einbohrband	16.1486/16 R	108	44/52	St 27.00

**Fischband**Eisen gerostet
Lappen seitlich

Bezeichnung	Bestellnummer	H	I	Ø	CHF
Fischband links	16.1180/060 Ls	45	95	8	St 20.00
Fischband rechts	16.1180/060 Rs	45	95	8	St 20.00
Fischband links	16.1180/080 Ls	50	120	9	St 21.00
Fischband rechts	16.1180/080 Rs	50	120	9	St 21.00
Fischband links	16.1180/100 Ls	60	150	10	St 21.50
Fischband rechts	16.1180/100 Rs	60	150	10	St 21.50
Fischband links	16.1180/120 Ls	70	180	12	St 22.00
Fischband rechts	16.1180/120 Rs	70	180	12	St 22.00
Fischband links	16.1180/140 Ls	80	205	13	St 27.50
Fischband rechts	16.1180/140 Rs	80	205	13	St 27.50
Fischband links	16.1180/160 Ls	95	230	14	St 32.50
Fischband rechts	16.1180/160 Rs	95	230	14	St 32.50

**Fischband**Eisen gerostet
Lappen mittig

Bezeichnung	Bestellnummer	H	I	Ø	CHF
Fischband/Lappen mittig	16.1181/060	45	95	8	St 20.00
Fischband/Lappen mittig	16.1181/080	50	120	9	St 21.00
Fischband/Lappen mittig	16.1181/100	60	150	10	St 21.50
Fischband/Lappen mittig	16.1181/120	70	180	12	St 22.00
Fischband/Lappen mittig	16.1181/140	80	200	13	St 27.50
Fischband/Lappen mittig	16.1181/160	95	230	14	St 32.50

Türband

Eisen gerostet

Bezeichnung	Bestellnummer	H	I	IR	H	Ø	≠	CHF
Türband ohne Kloben	16.305/255	140	255		5	12		St 137.50
Plattenstützkloben	16.305 B2	30	165	80	41	12	18	St 99.50
Bolzenstützkloben	16.305 D2	21	175		40	12	18	St 92.00



Türband

Eisen gerostet

Bezeichnung	Bestellnummer	H	I	H	Ø	≠	CHF
Türband ohne Kloben	16.324/240	146	240	6	12		St 135.00
Plattenkloben	16.324 A2	30	106	41	12	18	St 106.50



Türband

Eisen gerostet

Bezeichnung	Bestellnummer	H	I	IR	H	Ø	≠	CHF
Türband ohne Kloben	16.325/250	140	250		6	12		St 135.00
Plattenstützkloben	16.325 B2	30	150	80	46	12	18	St 119.50
Bolzenstützkloben	16.325 D2	29	150		46	12	18	St 95.00

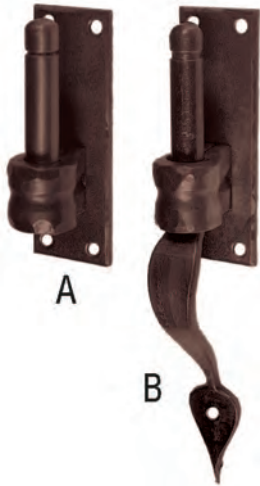

**Kloben**

Eisen gerostet

Bezeichnung	Bestellnummer	H	I	TR	H	Ø	≠	CHF
Plattenkloben	16.332 A2	40	123		46	15	18	St 107.50
Plattenkloben	16.332 A3	40	123		46	15	30	St 107.50
Plattenstützkloben	16.332 B2	40	225	123	52	15	18	St 146.00
Plattenstützkloben	16.332 B3	40	225	123	62	15	30	St 146.00

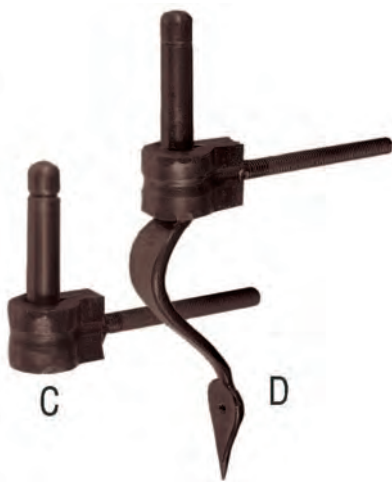
**Kloben**

Eisen gerostet

Bezeichnung	Bestellnummer	H	I	H	Ø	≠	CHF
Bolzenkloben	16.332 C2	30	93	45	15	18	St 101.50
Bolzenstützkloben	16.332 D2	30	225	54	15	18	St 112.50

**Türlangband**

Eisen gerostet

Bezeichnung	Bestellnummer	H	I	H	Ø	A	CHF
Türlangband	16.332/500	515	70	6	15	90	St 137.50
Türlangband	16.332/600	615	70	6	15	90	St 163.50
Türlangband	16.332/700	715	70	6	15	90	St 206.50
Türlangband	16.332/800	815	70	6	15	90	St 244.50

passende Kloben: siehe Art. 16.332

Eisen verzinkt-allpatiniert	Seite 6.07	Türklopfer			
Eisen naturblank Eisen verzinkt-allpatiniert Eisen gerostet	Seite 6.02 Seite 6.08 Seite 6.10	Türschlösser			
Eisen naturblank Eisen verzinkt-allpatiniert Eisen gerostet	Seite 6.05 Seite 6.09 Seite 6.10	Türriegel			
Eisen naturblank Eisen verzinkt-allpatiniert Eisen gerostet Bronze dunkel Bronze versilbert	Seite 6.06 Seite 6.09 Seite 6.11 Seite 6.11 Seite 6.11	Türstopper			

**Einsteckschloss Vario**

Eisen naturblank

Einlassmass 160x90x13 mm

Bezeichnung	Bestellnummer	H	I	⊥	⊜	CHF
Einsteckschloss	13.270/060 BB78 DIN Ls	18	230	60	8	St 69.00
Einsteckschloss	13.270/060 BB78 DIN Rs	18	230	60	8	St 69.00
Einsteckschloss	13.270/060 RZ78 DIN Ls	18	230	60	8	St 69.00
Einsteckschloss	13.270/060 RZ78 DIN Rs	18	230	60	8	St 69.00
Einsteckschloss	13.270/060 PZ78 DIN Ls	18	230	60	8	St 69.00
Einsteckschloss	13.270/060 PZ78 DIN Rs	18	230	60	8	St 69.00
Einsteckschloss	13.270/060 WC78 DIN Ls	18	230	60	8	St 74.00
Einsteckschloss	13.270/060 WC78 DIN Rs	18	230	60	8	St 74.00

**Schliessblech**

Eisen naturblank

Bezeichnung	Bestellnummer	H	I	H	CHF
Kappen-Schliessblech	13.270/K	18	140	14.5	St 11.00
Winkel-Schliessblech	13.270/W	18	167	12	St 11.00

**Zimmertürschloss**

Eisen naturblank

mit hebender Falle und Nachriegel / ohne Drückergarnitur

Bezeichnung	Bestellnummer	H	I	H	⊥	⊜	CHF
Zimmertürschloss	13.340 DIN Rs	115	85	22	65	8 18	St 300.00
Zimmertürschloss	13.340 DIN Ls	115	85	22	65	8 18	St 300.00

passender Aussendrücker: Art. 13.186

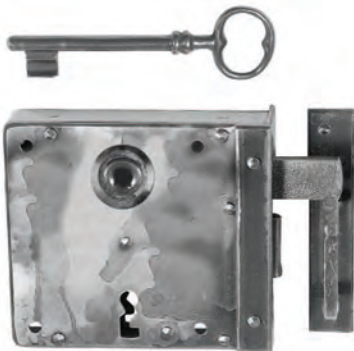
**Zimmertürschloss**

Eisen naturblank

mit hebender Falle / BB mit 1 Schlüssel / ohne Drückergarnitur

Bezeichnung	Bestellnummer	H	I	H	⊥	⊜	CHF
Zimmertürschloss	13.341 BB55 DIN Rs	110	100	22	60	8 18	St 410.00
Zimmertürschloss	13.341 BB55 DIN Ls	110	100	22	60	8 18	St 410.00
Zimmertürschloss	13.341 RZ55 DIN Rs	110	100	22	60	8 18	St 430.00
Zimmertürschloss	13.341 RZ55 DIN Ls	110	100	22	60	8 18	St 430.00

Zimmertürschloss

Eisen naturblank
mit hebender Falle / BB mit 1 Schlüssel / ohne Drückergarnitur

Bezeichnung	Bestellnummer	H	I	H	I	Ø	≠	CHF
Zimmertürschloss	13.342 BB55 DIN Rs	120	120	30	65	8	18	St 395.00
Zimmertürschloss	13.342 BB55 DIN Ls	120	120	30	65	8	18	St 395.00
Zimmertürschloss	13.342 RZ55 DIN Rs	120	120	30	65	8	18	St 415.00
Zimmertürschloss	13.342 RZ55 DIN Ls	120	120	30	65	8	18	St 415.00

passender Aussendrucker: Art. 13.182

**Zimmertürschloss**

Eisen naturblank
mit schiessender Falle / BB mit 1 Schlüssel / ohne Drückergarnitur

Bezeichnung	Bestellnummer	H	I	H	I	Ø	≠	CHF
Zimmertürschloss	13.343 BB55 DIN Rs	110	102	24	65	8	18	St 290.00
Zimmertürschloss	13.343 BB55 DIN Ls	110	102	24	65	8	18	St 290.00
Zimmertürschloss	13.343 RZ50.3 DIN Rs	110	102	24	65	8	18	St 310.00
Zimmertürschloss	13.343 RZ50.3 DIN Ls	110	102	24	65	8	18	St 310.00

**Zimmertürschloss**

Eisen naturblank
mit hebender Falle / BB mit 1 Schlüssel / ohne Drückergarnitur

Bezeichnung	Bestellnummer	H	I	H	I	Ø	≠	CHF
Zimmertürschloss	13.345 BB55 DIN Rs	165	110	27	70	8	18	St 560.00
Zimmertürschloss	13.345 BB55 DIN Ls	165	110	27	70	8	18	St 560.00
Zimmertürschloss	13.345 RZ55 DIN Rs	165	110	27	70	8	18	St 580.00
Zimmertürschloss	13.345 RZ55 DIN Ls	165	110	27	70	8	18	St 580.00

passender Aussendrucker: Art. 13.122

**Haustürschloss**

Eisen naturblank
schwer / 2-tourig / mit hebender Falle / ohne Drückergarnitur

Bezeichnung	Bestellnummer	H	I	H	I	Ø	≠	CHF
Haustürschloss	13.346/070 BB78 DIN Rs	200	130	32	70	9	18	St 725.00
Haustürschloss	13.346/070 BB78 DIN Ls	200	130	32	70	9	18	St 725.00
Haustürschloss	13.346/070 RZ78 DIN Rs	200	130	32	70	9	18	St 745.00
Haustürschloss	13.346/070 RZ78 DIN Ls	200	130	32	70	9	18	St 745.00
Haustürschloss	13.346/100 RZ78 DIN Rs	200	130	32	100	9	18	St 745.00
Haustürschloss	13.346/100 RZ78 DIN Ls	200	130	32	100	9	18	St 745.00

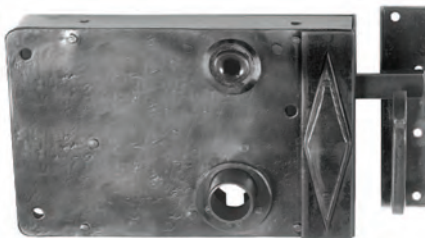

**Türschloss**

Eisen naturblank
mit Schletzfaller und Kloben / aussen mit Schild und Schlüssel

Bezeichnung	Bestellnummer	H	I	H	I	≠	CHF
Türschloss	13.360 BB DIN Rs	235	125	80	80	18	St 615.00
Türschloss	13.360 BB DIN Ls	235	125	80	80	18	St 615.00

benötigt keine Drückergarnitur

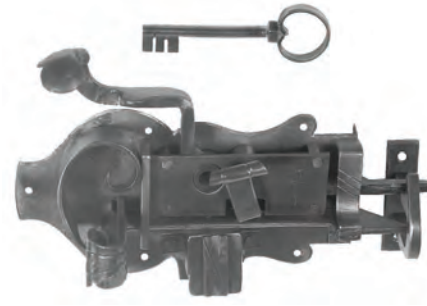
**Türschloss**

Eisen naturblank
mit hebender Falle / BB mit 1 Schlüssel / ohne Drückergarnitur

Bezeichnung	Bestellnummer	H	I	H	I	□	≠	CHF
Türschloss	13.361 BB55 DIN Rs	210	115	85	90	8	18	St 800.00
Türschloss	13.361 BB55 DIN Ls	210	115	85	90	8	18	St 800.00
Türschloss	13.361 RZ55 DIN Rs	210	115	85	90	8	18	St 820.00
Türschloss	13.361 RZ55 DIN Ls	210	115	85	90	8	18	St 820.00

passender Aussendrücker: Art. 13.122

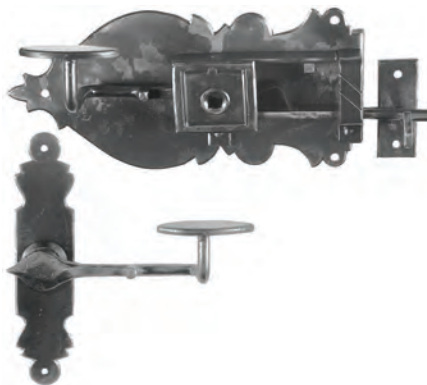
**Zimmertürschloss**

Eisen naturblank
mit hebender Falle / ohne Schlüssel / komplett mit äusserer Garnitur

Bezeichnung	Bestellnummer	H	I	H	I	□	≠	CHF
Zimmertürschloss mit Garnitur	13.365 DIN Rs	235	105	80	90	8	18	St 550.00
Zimmertürschloss mit Garnitur	13.365 DIN Ls	235	105	80	90	8	18	St 550.00

**Haustürschloss**



Eisen naturblank
mit hebender Falle / Sperriegel / BB mit 1 Schlüssel mit Zuhaltung

Bezeichnung	Bestellnummer	H	I	H	I	□	≠	CHF
Haustürschloss	13.366/090 BB55 DIN Rs	310	160	110	90	9	18	St1830.00
Haustürschloss	13.366/090 BB55 DIN Ls	310	160	110	90	9	18	St1830.00
Haustürschloss	13.366/090 RZ55 DIN Rs	310	160	110	90	9	18	St1860.00
Haustürschloss	13.366/090 RZ55 DIN Ls	310	160	110	90	9	18	St1860.00
Haustürschloss	13.366/120 BB55 DIN Rs	310	160	110	120	9	18	St1830.00
Haustürschloss	13.366/120 BB55 DIN Ls	310	160	110	120	9	18	St1830.00
Haustürschloss	13.366/120 RZ55 DIN Rs	310	160	110	120	9	18	St1860.00
Haustürschloss	13.366/120 RZ55 DIN Ls	310	160	110	120	9	18	St1860.00

passender Aussendrücker: Art. 15.152H

Tennturschloss





Eisen naturblank

Bezeichnung	Bestellnummer					CHF
Tennturschloss	13.387 DIN Rs	200	145	60	100	St 515.00
Tennturschloss	13.387 DIN Ls	200	145	60	100	St 515.00



Riegel





Eisen naturblank

Bezeichnung	Bestellnummer					\neq	\neq	CHF
Riegel	13.249/150 R	140	30	100			4	St 88.50
Einschlagkloben	13.249.1	31		70				St 21.00
Riegelschlaufe	13.249.2	13		58		0		St 21.00
Riegelschlaufe	13.249.2/18	13		58		18		St 21.00
Schliessblech flach	13.249.3	20		48				St 17.00



Riegel



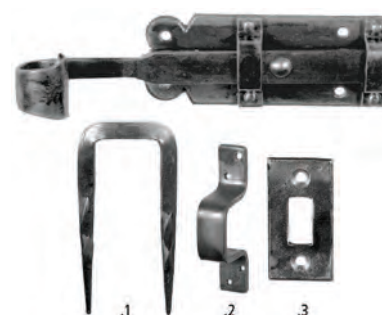

Eisen naturblank

Bezeichnung	Bestellnummer					\neq	\neq	CHF
Riegel	13.250/150 R	150	40	100			6	St 97.00
Einschlagkloben	13.250.1	34		85				St 21.00
Riegelschlaufe	13.250.2	15		64		0		St 21.00
Riegelschlaufe	13.250.2/18	15		60		18		St 21.00
Schliessblech flach	13.250.3	25		54				St 17.00



Riegel



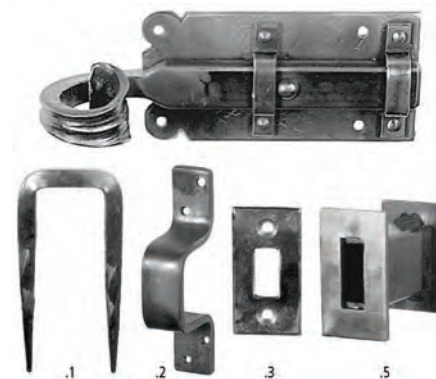

Eisen naturblank

Bezeichnung	Bestellnummer					\neq	\neq	CHF
Riegel	13.251/180 R	180	60	120			10	St 126.00
Riegel	13.251/350 R	350	60	120			10	St 135.00
Einschlagkloben	13.251.1	50		95				St 22.00
Riegelschlaufe	13.251.2	20		97		0		St 25.50
Riegelschlaufe	13.251.2/18	20		100		18		St 25.50
Schliessblech flach	13.251.3	30		60				St 19.00
Riegelhulse	13.251.5	30		60				St 45.00



Riegel schwer

Eisen naturblank

Bezeichnung	Bestellnummer					\neq	\neq	CHF
Riegel schwer	13.252/270 R	270	70	180			12	St 185.00
Riegel schwer	13.252/500 R	500	70	180			12	St 210.00
Einschlagkloben	13.252.1	50		130				St 24.00
Riegelschlaufe	13.252.2	30		130		0		St 37.00
Riegelschlaufe	13.252.2/18	30		122		18		St 37.00
Schliessblech flach	13.252.3	40		72				St 27.50
Riegelhulse	13.252.5	30		60				St 54.50

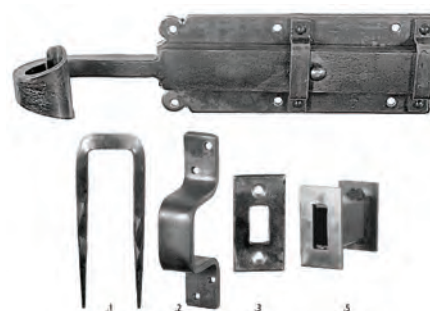

**Bernerfalle**Eisen naturblank
Holzdicke 40-75 mm

Bezeichnung	Bestellnummer	H	I	H	≠	≠	CHF
Bernerfalle	13.385	255	265	65	0+18	6	St 260.00

**Bernerfalle**Eisen naturblank
Holzdicke 40-75 mm

Bezeichnung	Bestellnummer	H	I	H	≠	≠	CHF
Bernerfalle	13.386	220	225	35	0+18	6	St 192.00

**Riegel**

Eisen naturblank

Bezeichnung	Bestellnummer	H	I	H	≠	≠	CHF
Riegel	13.388	210	55	35	0+18	6	St 149.00

**Türstopper Serie Zinal**

Eisen naturblank

Bezeichnung	Bestellnummer	H	I	H	≠	CHF
Türstopper	13.850	25	25	35	6	St 34.50

**Türstopper**

Eisen naturblank

Bezeichnung	Bestellnummer	H	H	≠	CHF
Türstopper	13.851	36	42	6	St 26.50

Türklopfer

Türklopfer

Eisen verzinkt-altpatiniert

Bezeichnung	Bestellnummer						CHF
Türklopfer	15.239 K	110	200	36	115	M8	St 244.00



Türklopfer

Eisen verzinkt-altpatiniert

Bezeichnung	Bestellnummer						CHF
Türklopfer	15.240 K	135	210	38	130	M8	St 319.00



Türklopfer

Eisen verzinkt-altpatiniert

Bezeichnung	Bestellnummer						CHF
Türklopfer	15.241 K	92	185	110	110	M8	St 243.00



**Türklopper**

Eisen verzinkt-altpatiniert

Bezeichnung	Bestellnummer	H	I	H	mm	CHF
Türklopper	15.246 K	125	130	35	M8	St 243.00

**Türklopper**

Eisen verzinkt-altpatiniert

Bezeichnung	Bestellnummer	H	I	H	mm	CHF
Türklopper	15.247 K	125	130	35	M8	St 348.00

**Einsteckschloss Vario**

Eisen verzinkt-altpatiniert

Einlassmass 160x90x13 mm

Bezeichnung	Bestellnummer	H	I	mm	mm	mm	mm	CHF
Einsteckschloss	15.270/060 BB78 DIN Ls	18	230	60	8			St 74.00
Einsteckschloss	15.270/060 BB78 DIN Rs	18	230	60	8			St 74.00
Einsteckschloss	15.270/060 RZ78 DIN Ls	18	230	60	8			St 74.00
Einsteckschloss	15.270/060 RZ78 DIN Rs	18	230	60	8			St 74.00
Einsteckschloss	15.270/060 PZ78 DIN Ls	18	230	60	8			St 74.00
Einsteckschloss	15.270/060 PZ78 DIN Rs	18	230	60	8			St 74.00
Einsteckschloss	15.270/060 WC78 DIN Ls	18	230	60	8			St 79.00
Einsteckschloss	15.270/060 WC78 DIN Rs	18	230	60	8			St 79.00

**Schliessblech**

Eisen verzinkt-altpatiniert

Bezeichnung	Bestellnummer	H	I	H	CHF
Kappen-Schliessblech	15.270/K	18	140	14.5	St 13.00
Winkel-Schliessblech	15.270/W	18	167	12	St 13.00

Zimmertürschloss

Eisen verzinkt-altpatiniert
mit hebender Falle / BB mit 1 Schlüssel / ohne Drückergarnitur

Bezeichnung	Bestellnummer	H	I	H	I	Ø	≠	CHF
Zimmertürschloss	15.341 BB55 DIN Rs	110	100	22	60	8	18	St 490.00
Zimmertürschloss	15.341 BB55 DIN Ls	110	100	22	60	8	18	St 490.00
Zimmertürschloss	15.341 RZ55 DIN Rs	110	100	22	60	8	18	St 510.00
Zimmertürschloss	15.341 RZ55 DIN Ls	110	100	22	60	8	18	St 510.00

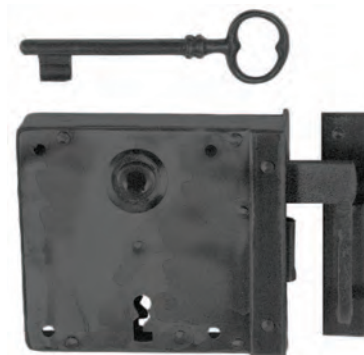

Riegel

Eisen verzinkt-altpatiniert

Bezeichnung	Bestellnummer	H	R	I	I	≠	≠	CHF
Riegel	15.250/150 R	150	40	100			6	St 114.00
Einschlagkloben	15.250.1	34		85				St 25.00
Riegelschlaufe	15.250.2	15		64		0		St 25.00
Riegelschlaufe	15.250.2/18	15		60		18		St 25.00
Schliessblech flach	15.250.3	25		54				St 21.00

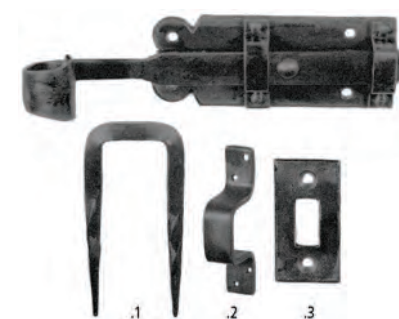

Türriegel

Eisen verzinkt-altpatiniert
innen mit Abdeckplatte und Knopf zum Schieben

Bezeichnung	Bestellnummer	H	I	H	≠	CHF
Türriegel	15.380	620	160	60	10	St 1965.00



Türriegel

Eisen verzinkt-altpatiniert

Bezeichnung	Bestellnummer	H	I	H	≠	CHF
Türriegel	15.382	470	70	35	10	St 1212.00



Bernerfalle

Eisen verzinkt-altpatiniert
Holzdicke 40-75 mm

Bezeichnung	Bestellnummer	H	I	H	≠	≠	CHF
Bernerfalle	15.386	220	120	35	0+18	6	St 242.00



Türstopper Serie Zinal

Eisen verzinkt-altpatiniert

Bezeichnung	Bestellnummer	H	I	H	≠	CHF
Türstopper	15.850	25	25	35	6	St 42.00



**Einsteckschloss Vario**

Eisen gerostet
Einlassmass 160x90x13 mm

Bezeichnung	Bestellnummer	H	I	⊥	⊜	CHF
Einsteckschloss	16.270/060 BB78 DIN Ls	18	230	60	8	St 79.00
Einsteckschloss	16.270/060 BB78 DIN Rs	18	230	60	8	St 79.00
Einsteckschloss	16.270/060 RZ78 DIN Ls	18	230	60	8	St 79.00
Einsteckschloss	16.270/060 RZ78 DIN Rs	18	230	60	8	St 79.00
Einsteckschloss	16.270/060 PZ78 DIN Ls	18	230	60	8	St 79.00
Einsteckschloss	16.270/060 PZ78 DIN Rs	18	230	60	8	St 79.00
Einsteckschloss	16.270/060 WC78 DIN Ls	18	230	60	8	St 84.00
Einsteckschloss	16.270/060 WC78 DIN Rs	18	230	60	8	St 84.00

**Schliessblech**

Eisen gerostet

Bezeichnung	Bestellnummer	H	I	H	CHF
Kappen-Schliessblech	16.270/K	18	140	14.5	St 15.00
Winkel-Schliessblech	16.270/W	18	167	12	St 15.00

**Zimmerturschloss**

Eisen gerostet
mit hebender Falle / BB mit 1 Schlussel / ohne Druckergarnitur

Bezeichnung	Bestellnummer	H	I	H	⊥	⊜	CHF
Zimmerturschloss	16.341 BB55 DIN Rs	110	100	22	60	8 18	St 525.00
Zimmerturschloss	16.341 BB55 DIN Ls	110	100	22	60	8 18	St 525.00

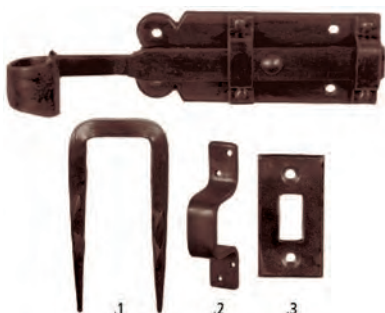
**Riegel**

Eisen gerostet

Bezeichnung	Bestellnummer	H	H	I	H	⊜	⊜	CHF
Riegel	16.250/150 R	150	40	100			6	St 122.00
Einschlagkloben	16.250.1	34		85				St 26.50
Riegelschlaufe	16.250.2	15		64		0		St 26.50
Riegelschlaufe	16.250.2/18	15		60		18		St 26.50
Schliessblech flach	16.250.3	25		54				St 22.50

Türstopper Serie Zinal

Eisen gerostet

Bezeichnung	Bestellnummer	H	I	H	mm	CHF
Türstopper	16.850	25	25	35	6	St 42.00



Türstopper Serie Latus

Bronze dunkel



Bezeichnung	Bestellnummer	H	I	H	mm	CHF
Türstopper	80.1851	25	25	32	6	St 29.00









Türstopper Serie Latus

Bronze versilbert



Bezeichnung	Bestellnummer	H	I	H	mm	CHF
Türstopper	83.1851	25	25	32	6	St 35.00

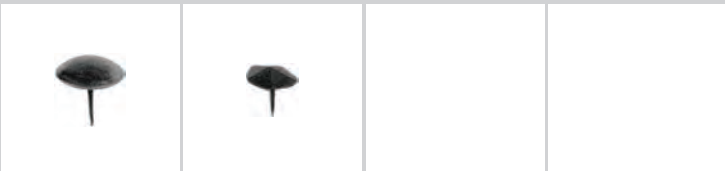

Eisen naturblank	Seite 7.02	<p>Handlaufbeschläge</p> 			
Eisen naturblank	Seite 7.02	<p>Haken und Hakenleisten</p> 			
Eisen verzinkt-altpatiniert	Seite 7.08				
Eisen gerostet	Seite 7.12				
Eisen naturblank	Seite 7.04	<p>Konsolen und Kleiderträger</p> 			
Eisen naturblank	Seite 7.05	<p>Garderobe- und Vorhangstangen</p> 			
Eisen verzinkt-altpatiniert	Seite 7.08	<p>Zierkappen</p> 			
Eisen blank	Seite 7.12				
Eisen verzinkt-altpatiniert	Seite 7.08	<p>Badaccessoires</p> 			
Bronze dunkel	Seite 7.13				
Bronze versilbert	Seite 7.15				

**Handlaufstütze**

Eisen naturblank

Bezeichnung	Bestellnummer	H	I	H	I	CHF
Handlaufstütze	13.914	58	100	73	65	St 59.00

**Handlaufstütze**

Eisen naturblank

Bezeichnung	Bestellnummer	H	I	H	I	CHF
Handlaufstütze	13.915	70	120	82	75	St 89.00

**Handlaufstütze Serie Zinal**

Eisen naturblank

Bezeichnung	Bestellnummer	H	I	H	I	CHF
Handlaufstütze	13.916	58	89	82	75	St 75.00

**Haken**

Eisen naturblank

Bezeichnung	Bestellnummer	H	I	H	∞	CHF
Haken	13.615	61	57	33	17	St 29.00

**Haken Serie Zinal**

Eisen naturblank

Bezeichnung	Bestellnummer	H	I	H	CHF
Haken	13.620/40	10	40	40	St 25.00

**Haken Serie Pollux**

Eisen naturblank

Bezeichnung	Bestellnummer	H	I	H	∞	≠	CHF
Haken	13.630/35	8	40	35	14	8	St 39.50
Haken	13.630/55	10	60	55	18	10	St 43.50





**Haken Serie Pollux**

Eisen naturblank

Bezeichnung	Bestellnummer	H	I	H	∞	≠	CHF
Haken	13.631	10	120	55	18	10	St 46.50

Haken

Eisen naturblank

Bezeichnung	Bestellnummer						CHF
Haken	13.632/30	12	40	30	14	3	St 22.50
Haken	13.632/50	18	60	50	18	5	St 25.00

Haken

Eisen naturblank

Bezeichnung	Bestellnummer						CHF
Haken	13.633	18	120	50	18	5	St 38.00

Haken

Eisen naturblank

Bezeichnung	Bestellnummer				CHF
Haken	13.787	80	45	42	St 59.50

Haken

Eisen naturblank

Bezeichnung	Bestellnummer				CHF
Haken	13.790	28	50	26	St 22.50

Haken

Eisen naturblank

Bezeichnung	Bestellnummer				CHF
Haken	13.791	42	56	30	St 36.50

Haken

Eisen naturblank

Bezeichnung	Bestellnummer				CHF
Haken	13.792	56	165	95	St 44.50

Haken

Eisen naturblank

Bezeichnung	Bestellnummer				CHF
Haken	13.793	53	65	41	St 42.00



**Haken**

Eisen naturblank

Bezeichnung	Bestellnummer	H	I	H	CHF
Haken	13.794/55	53	73	41	St 48.00
Haken	13.794/70	68	85	48	St 53.00

**Haken**

Eisen naturblank

Bezeichnung	Bestellnummer	H	I	H	CHF
Haken	13.795	68	165	75	St 61.50

**Haken mit Rosette**

Eisen naturblank

Bezeichnung	Bestellnummer	H	I	H	CHF
Haken mit Rosette	13.797/35	30	37	45	St 33.00
Haken mit Rosette	13.797/55	40	43	55	St 44.00
Haken mit Rosette	13.797/75	60	65	80	St 59.00

**Handtuchstange**

Eisen naturblank

Bezeichnung	Bestellnummer	H	H	I	H	o	CHF
Handtuchstange	13.800/448	488	40	40	45	27	St 115.00

**Kleiderbügelschraube**

Eisen naturblank

Bezeichnung	Bestellnummer	H	I	□	▨	CHF
Kleiderbügelschraube	13.608	43	110	5	4	St 18.00

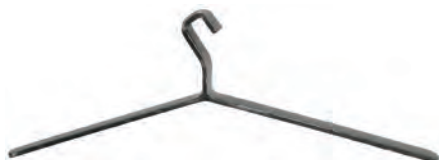
**Kleiderbügel**

Eisen naturblank

Bezeichnung	Bestellnummer	H	I	≠	CHF
Kleiderbügel	13.798	480	160	6	St 69.00

**Kleiderbügel**

Eisen naturblank

Bezeichnung	Bestellnummer	H	I	≠	CHF
Kleiderbügel	13.799	480	180	6	St 69.00

Wandlager

Eisen naturblank

Bezeichnung	Bestellnummer	H	I	H	∅	CHF
Wandlager geschlossen	13.765	50	50	20	15	St 26.00
Wandlager offen	13.765 A	50	50	20	15	St 31.50



Mittelträger

Eisen naturblank

Bezeichnung	Bestellnummer	H	I	H	i	∅	CHF
Mittelträger	13.766	50	50	90	75	15	St 50.00

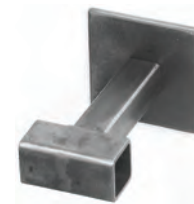

Haken

Eisen naturblank

Bezeichnung	Bestellnummer	H	I	∅	CHF
Haken	13.766 H	24	62	15	St 11.00



Zierende

Eisen naturblank

Bezeichnung	Bestellnummer	H	I	∅	CHF
Zierende	13.767	66	40	15	St 73.00



Zierende

Eisen naturblank

Bezeichnung	Bestellnummer	H	I	∅	CHF
Zierende	13.768	115	70	15	St 78.00



Zierende

Eisen naturblank

Bezeichnung	Bestellnummer	H	I	∅	CHF
Zierende	13.769	65	45	15	St 73.00



Mittelträger

Eisen naturblank

Bezeichnung	Bestellnummer	H	I	H	i	∅	CHF
Mittelträger	13.770 M	65	110	85	65	15	St 89.50



**Zierende mit Träger**

Eisen naturblank

Bezeichnung	Bestellnummer	H	I	H	I	Ø	CHF
Zierende mit Träger	13.770 Ls	190	220	85	65	15	St 178.00
Zierende mit Träger	13.770 Rs	190	220	85	65	15	St 178.00

**Zierende mit Träger**

Eisen naturblank

Bezeichnung	Bestellnummer	H	I	H	I	Ø	CHF
Zierende mit Träger	13.773	180	110	95	65	15	St 124.00

**Mittelträger**

Eisen naturblank

Bezeichnung	Bestellnummer	H	I	H	I	Ø	CHF
Mittelträger	13.773 M	40	110	95	65	15	St 62.00

**Vorhang-Ring**

Eisen naturblank

Bezeichnung	Bestellnummer	H	Ø	CHF
Vorhang-Ring	13.774	43	5	St 9.50

**Vorhang-Ring**

Eisen naturblank

Bezeichnung	Bestellnummer	H	I	Ø	CHF
Vorhang-Ring	13.775	35	60	5	St 9.50

**Stange für Garderoben oder Vorhänge**

Eisen naturblank

Bezeichnung	Bestellnummer	H	Ø	CHF
Stange rund auf Mass	13.776	?	15	m 130.00
Stange rund	13.776/1000	1000	15	St 103.00
Stange rund	13.776/1300	1300	15	St 134.00
Stange rund	13.776/1500	1500	15	St 155.00
Stange rund	13.776/1800	1800	15	St 185.00
Stange rund	13.776/2000	2000	15	St 206.00
Stange rund	13.776/2200	2200	15	St 229.00

Wandlager

Eisen naturblank

Bezeichnung	Bestellnummer	H	H	∅	∅	CHF
Wandlager geschlossen	13.777	50	22	15	36	St 27.00
Wandlager offen	13.777 A	50	22	15	36	St 31.50



Mittelträger

Eisen naturblank

Bezeichnung	Bestellnummer	H	H	I	∅	∅	CHF
Mittelträger	13.778	42	90	75	15	27	St 62.00



Haken

Eisen naturblank

Bezeichnung	Bestellnummer	H	I	∅	CHF
Haken	13.779	35	70	15	St 11.00



Stange für Garderoben oder Vorhänge

Eisen naturblank

Bezeichnung	Bestellnummer	H	∅	CHF
Stange quadrat. auf Mass	13.780	?	15	m 75.00
Stange quadratisch	13.780/1000	1000	15	St 50.00
Stange quadratisch	13.780/1300	1300	15	St 65.00
Stange quadratisch	13.780/1500	1500	15	St 75.00
Stange quadratisch	13.780/1800	1800	15	St 90.00
Stange quadratisch	13.780/2000	2000	15	St 100.00
Stange quadratisch	13.780/2200	2200	15	St 110.00



Wandlager

Eisen naturblank

Bezeichnung	Bestellnummer	H	I	H	∅	∅	CHF
Wandlager geschlossen	13.781	70	70	20	15	35	St 27.50
Wandlager offen	13.781 A	70	70	20	15	35	St 33.00



Mittelträger

Eisen naturblank

Bezeichnung	Bestellnummer	H	I	H	I	∅	∅	CHF
Mittelträger	13.782	70	70	90	75	15	35	St 51.00

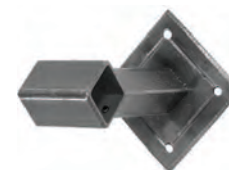

Haken

Eisen naturblank

Bezeichnung	Bestellnummer	H	I	∅	CHF
Haken	13.783	43	73	15	St 11.50





Haken Serie Zinal

Eisen verzinkt-altpatiniert

Bezeichnung	Bestellnummer	H	I	H	CHF
Haken	15.620/40	10	40	40	St 29.00

Ziernagel zentrisch

Eisen verzinkt-altpatiniert

Bezeichnung	Bestellnummer	H	Ø	⊞	CHF
Ziernagel zentrisch	15.272/22 mm	26	22	100/20	St 4.80
Ziernagel zentrisch	15.272/25 mm	30	25	100/20	St 6.25

Ziernagel versetzt

Eisen verzinkt-altpatiniert

Bezeichnung	Bestellnummer	H	Ø	⊞	CHF
Ziernagel versetzt	15.273/22 mm	26	22	100/20	St 4.80
Ziernagel versetzt	15.273/25 mm	30	25	100/20	St 6.25



Handtuchstange

Eisen verzinkt-altpatiniert

Bezeichnung	Bestellnummer	H	H _B	I _R	H	⊞	CHF
Handtuchstange	15.800/448	488	40	40	45	27	St 148.00



Badetuchstange

Eisen verzinkt-altpatiniert

Bezeichnung	Bestellnummer	H	I	H	I	⊞	CHF
Badetuchstange	15.820/600	652	52	75	65	600	St 175.00
Badetuchstange	15.820/800	852	52	75	65	800	St 190.00



Handtuchhalter

Eisen verzinkt-altpatiniert

Bezeichnung	Bestellnummer	H	I	H	⊞	CHF
Handtuchhalter links	15.821 Ls	260	45	100	40	St 135.00
Handtuchhalter rechts	15.821 Rs	260	45	100	40	St 135.00



Reserverollenhalter

Eisen verzinkt-altpatiniert
Wandmodell

Bezeichnung	Bestellnummer	H	I	H	⊞	CHF
Reserverollenhalter	15.822	135	30	150	35	St 135.00

Papierhalter

Eisen verzinkt-altpatiniert

Bezeichnung	Bestellnummer	H	I	H	∞	CHF
Papierhalter	15.823	130	45	85	40	St 125.00



Seifenhalter

Eisen verzinkt-altpatiniert / Seifenschale aus Porzellan

Wandmodell

Bezeichnung	Bestellnummer	H	I	H	∞	CHF
Seifenhalter	15.826	118	35	133	35	St 170.00



Glshalter

Eisen verzinkt-altpatiniert / Becher aus Porzellan

Wandmodell

Bezeichnung	Bestellnummer	H	I	H	∞	CHF
Glshalter	15.827	82	110	97	35	St 170.00



Seifenspender

Eisen verzinkt-altpatiniert / Spender aus Porzellan

Wandmodell

Bezeichnung	Bestellnummer	H	I	H	∞	CHF
Seifenspender	15.828	82	225	97	35	St 185.00





Klosettbürstenhalter

Eisen verzinkt-altpatiniert / Behälter aus Porzellan
Standmodell

Bezeichnung	Bestellnummer	H	I	H	CHF
Klosettbürstenhalter	15.834	110	400	110	St 360.00

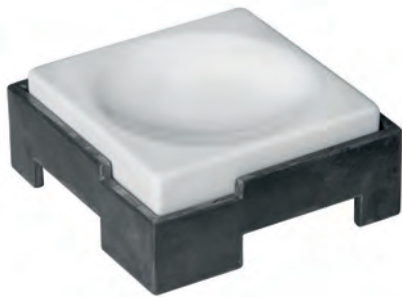

Seifenhalter

Eisen verzinkt-altpatiniert / Seifenschale aus Porzellan
Standmodell

Bezeichnung	Bestellnummer	H	I	CHF
Seifenhalter	15.836	118	50	St 170.00



Glashalter

Eisen verzinkt-altpatiniert / Becher aus Porzellan
Standmodell

Bezeichnung	Bestellnummer	H	I	CHF
Glashalter	15.837	82	125	St 170.00

Seifenspender

Eisen verzinkt-altpatiniert / Spender aus Porzellan
Standmodell

Bezeichnung	Bestellnummer	H	I	CHF
Seifenspender	15.838	82	240	St 185.00



**Haken**

Eisen gerostet

Bezeichnung	Bestellnummer	H	I	H	∅	CHF
Haken	16.615	61	57	33	17	St 36.00

**Haken Serie Zinal**

Eisen gerostet

Bezeichnung	Bestellnummer	H	I	H	CHF
Haken	16.620/40	10	40	40	St 32.00

**Haken**

Eisen gerostet

Bezeichnung	Bestellnummer	H	I	H	CHF
Haken	16.790	28	50	26	St 29.50

**Haken**

Eisen gerostet

Bezeichnung	Bestellnummer	H	I	H	CHF
Haken	16.791	42	56	30	St 46.50

**Haken**

Eisen gerostet

Bezeichnung	Bestellnummer	H	I	H	CHF
Haken	16.792	56	165	95	St 59.50

**Kuppennagel**

Eisen blank

Bezeichnung	Bestellnummer	H	∅	CHF
Kuppennagel	18.274/30 mm	28	30	St 9.50

Badetuchstange

Bronze dunkel

Bezeichnung	Bestellnummer	I	o-o	CHF
Badetuchstange	80.820/260	40	260	St 168.00
Badetuchstange	80.820/460	40	460	St 210.00



Papierhalter

Bronze dunkel

Bezeichnung	Bestellnummer	H	I	CHF
Papierhalter	80.823	135	35	St 140.00



Klosettbürstenhalter

Bronze dunkel
Standmodell / Behälter aus Porzellan

Bezeichnung	Bestellnummer	H	I	CHF
Klosettbürstenhalter	80.824	125	370	St 499.00



Haken

Bronze dunkel

Bezeichnung	Bestellnummer	H	I	H	o-o	CHF
Haken	80.825.1	40	35	35	30	St 52.00



Haken

Bronze dunkel

Bezeichnung	Bestellnummer	H	I	H	o-o	CHF
Haken	80.825.2	60	35	35	30	St 56.00

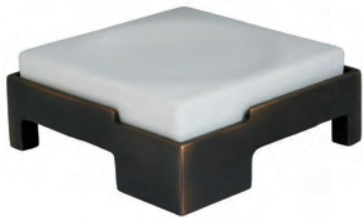

**Seifenhalter**

Bronze dunkel
Standmodell / Seifenschale aus Porzellan



Bezeichnung	Bestellnummer	H	I	CHF
Seifenhalter	80.826	110	50	St 210.00

**Glashalter**

Bronze dunkel
Standmodell / Becher aus Porzellan



Bezeichnung	Bestellnummer	H	I	CHF
Glashalter	80.827	100	105	St 245.00

**Seifenspender**

Bronze dunkel
Standmodell / Spender aus Porzellan



Bezeichnung	Bestellnummer	H	I	CHF
Seifenspender	80.828	100	220	St 280.00

Badetuchstange

Bronze versilbert

Bezeichnung	Bestellnummer	I	∞	CHF
Badetuchstange	83.820/260	40	260	St 210.00
Badetuchstange	83.820/460	40	460	St 275.00



Papierhalter

Bronze versilbert

Bezeichnung	Bestellnummer	H	I	CHF
Papierhalter	83.823	135	35	St 175.00



Klosettbürstenhalter

Bronze versilbert

Standmodell / Behälter aus Porzellan

Bezeichnung	Bestellnummer	H	I	CHF
Klosettbürstenhalter	83.824	125	370	St 650.00



Haken

Bronze versilbert

Bezeichnung	Bestellnummer	H	I	H	∞	CHF
Haken	83.825.1	40	35	35	30	St 68.00



Haken

Bronze versilbert

Bezeichnung	Bestellnummer	H	I	H	∞	CHF
Haken	83.825.2	60	35	35	30	St 72.00

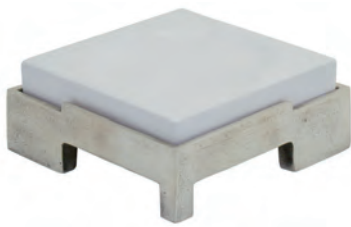

**Seifenhalter**

Bronze versilbert
Standmodell / Seifenschale aus Porzellan



Bezeichnung	Bestellnummer	H	I	CHF
Seifenhalter	83.826	110	50	St 275.00

**Glashalter**

Bronze versilbert
Standmodell / Becher aus Porzellan



Bezeichnung	Bestellnummer	H	I	CHF
Glashalter	83.827	100	105	St 315.00

**Seifenspender**

Bronze versilbert
Standmodell / Spender aus Porzellan



Bezeichnung	Bestellnummer	H	I	CHF
Seifenspender	83.828	100	220	St 350.00

Eisen naturblank
Eisen verzinkt-allpatiniert
Eisen gerostet
Bronze dunkel
Bronze versilbert

Seite 8.02
Seite 8.17
Seite 8.19
Seite 8.27
Seite 8.28

Griffe



Eisen naturblank
Eisen verzinkt-allpatiniert
Eisen gerostet
Bronze dunkel
Bronze versilbert

Seite 8.04
Seite 8.17
Seite 8.20
Seite 8.27
Seite 8.28

Knöpfe



Eisen naturblank
Eisen verzinkt-allpatiniert
Eisen gerostet
Bronze dunkel
Bronze versilbert

Seite 8.07
Seite 8.18
Seite 8.21
Seite 8.27
Seite 8.28

Schrankoliven und Schrankknöpfe



Eisen naturblank
Eisen verzinkt-allpatiniert
Eisen gerostet

Seite 8.08
Seite 8.18
Seite 8.22

Schilder



Eisen naturblank
Eisen gerostet
Eisen blank

Seite 8.11
Seite 8.23
Seite 8.25

Schlüssel und Schlüsselköpfe

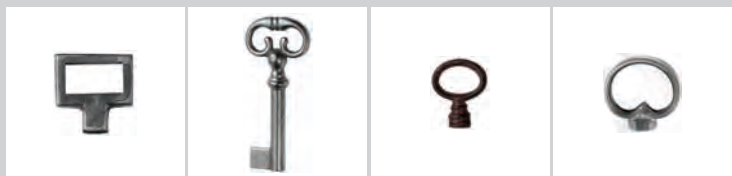

Eisen naturblank
Eisen gerostet

Seite 8.12
Seite 8.24

Bänder

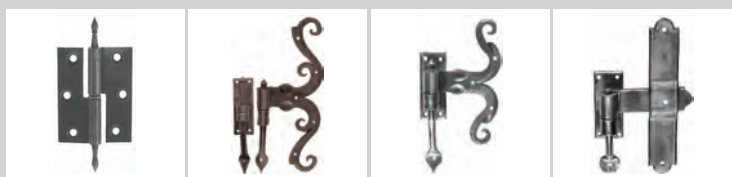

Eisen blank

Seite 8.25

Schrankfedern



Eisen naturblank
Eisen blank

Seite 8.15
Seite 8.25

Schlösser

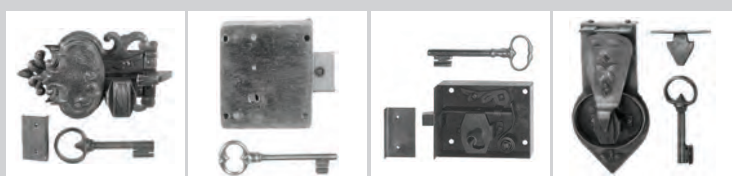

**Bügelgriff Serie Dom**

Eisen naturblank

Bezeichnung	Bestellnummer	H	I	∅	≠	CHF
Bügelgriff	13.1026/096	142	38	96	M4	St 39.50
Bügelgriff	13.1026/128	174	38	128	M4	St 42.50

**Bügelgriff**

Eisen naturblank

Bezeichnung	Bestellnummer	H	I	H	∅	CHF
Bügelgriff	13.1248	110	26	35	90	St 59.00

**Bügelgriff**

Eisen naturblank

Bezeichnung	Bestellnummer	H	I	H	∅	CHF
Bügelgriff	13.1250/120	120	18	37	87	St 38.00
Bügelgriff	13.1250/150	150	18	39	117	St 39.50

**Bügelgriff Serie Zinal**

Eisen naturblank

Bezeichnung	Bestellnummer	H	I	H	∅	≠	CHF
Bügelgriff	13.1252/096	104	8	28	96	8 M4	St 37.50
Bügelgriff	13.1252/128	136	8	28	128	8 M4	St 40.50
Bügelgriff	13.1252/160	170	10	32	160	10 M4	St 43.50

**Hängegriff**

Eisen naturblank

Bezeichnung	Bestellnummer	H	I	H	∅	≠	CHF
Hängegriff	13.1253	88	65	14	62	M4	St 42.50

**Ringgriff**

Eisen naturblank

Bezeichnung	Bestellnummer	H	I	H	∅	≠	CHF
Ringgriff mit Rosette	13.1254	52	70	19	43	M4	St 64.00
Ringgriff ohne Rosette	13.1254/50	50	54	17		M4	St 44.50

**Bügelgriff**

Eisen naturblank

Bezeichnung	Bestellnummer	H	I	H	∅	≠	CHF
Bügelgriff	13.1255	140	18	36	120	8	St 38.00

**Bügelgriff Serie Alv**

Eisen naturblank

Bezeichnung	Bestellnummer	H	I	H	∅	≠	CHF
Bügelgriff	13.1256/096	106	15	36	96	M4	St 49.00
Bügelgriff	13.1256/128	138	15	36	128	M4	St 52.00
Bügelgriff	13.1256/160	170	15	36	160	M4	St 55.00
Bügelgriff	13.1256/448	458	15	36	448	M5	St 78.00

Bügelgriff Serie Zinal

Eisen naturblank

Bezeichnung	Bestellnummer	H	I	H	∞	■	CHF
Bügelgriff	13.1257/096	108	35	12	96	M4	St 38.50
Bügelgriff	13.1257/128	140	35	12	128	M4	St 41.50
Bügelgriff	13.1257/160	172	35	12	160	M4	St 44.50

**Ringgriff mit Rosette**

Eisen naturblank

Bezeichnung	Bestellnummer	H	I	H	∞	■	CHF
Ringgriff mit Rosette	13.1258	52	70	19	43	M4	St 70.50

**Bügelgriff Serie Pollux**

Eisen naturblank

Bezeichnung	Bestellnummer	H	I	H	∞	■	CHF
Bügelgriff	13.1350/096	106	14	32	96	M4	St 39.50
Bügelgriff	13.1350/128	138	14	32	128	M4	St 42.50

**Bügelgriff Serie Zupò**

Eisen naturblank

Bezeichnung	Bestellnummer	H	I	H	∞	■	CHF
Bügelgriff	13.1351/096	106	10	34	96	M4	St 37.50
Bügelgriff	13.1351/128	138	10	34	128	M4	St 40.50
Bügelgriff	13.1351/160	170	10	34	160	M4	St 43.50
Bügelgriff	13.1351/192	202	10	34	192	M4	St 45.50

**Bügelgriff Serie Spedia**

Eisen naturblank

Bezeichnung	Bestellnummer	H	I	H	∞	■	CHF
Bügelgriff	13.1352/096	106	14	32	96	M4	St 39.50
Bügelgriff	13.1352/128	138	14	32	128	M4	St 42.50
Bügelgriff	13.1352/160	170	14	32	160	M4	St 45.50
Bügelgriff	13.1352/192	202	14	32	192	M4	St 48.50

**Griffleistenprofil Serie Bernina**

Eisen naturblank

zum Aufschrauben hinter Schubladendoppel

Bezeichnung	Bestellnummer	H	I	H	∞	CHF
Griffleistenprofil	13.1360/0064	104	18	41	64	St 33.50
Griffleistenprofil	13.1360/0096	136	18	41	96	St 36.50
Griffleistenprofil	13.1360/0128	168	18	41	128	St 39.50
Griffleistenprofil	13.1360/0192	232	18	41	192	St 45.50
Griffleistenprofil	13.1360/1200	1200	18	41		St 120.00

**Möbelgriff Serie Alv**

Eisen naturblank

Bezeichnung	Bestellnummer	H	I	H	∞	■	CHF
Möbelgriff	13.1365/064	74	25	20	64	M4	St 36.00
Möbelgriff	13.1365/096	106	25	20	96	M4	St 41.00
Möbelgriff	13.1365/128	138	25	20	128	M4	St 44.00
Möbelgriff	13.1365/160	170	25	20	160	M4	St 47.50



**Truhengriff**

Eisen naturblank

Bezeichnung	Bestellnummer	H	I	H	∅	Ø	CHF
Truhengriff	13.1750	115	80	25	45	M6x45	St 97.00

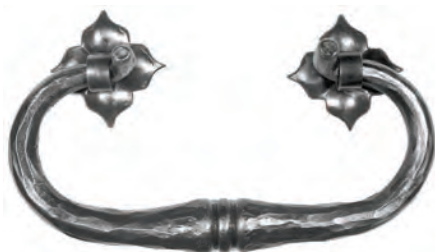
**Truhengriff**

Eisen naturblank

Bezeichnung	Bestellnummer	H	I	H	∅	Ø	CHF
Truhengriff	13.1752	175	105	35	80	M6x45	St 149.50

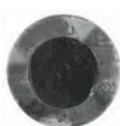
**Einlassgriff**

Eisen naturblank

Bezeichnung	Bestellnummer	H	H	H	∅	CHF
Einlassgriff	13.1218/40	40	2	10	30	St 39.00
Einlassgriff	13.1218/50	50	2	10	40	St 42.00

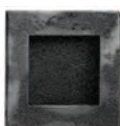
**Einlassgriff**

Eisen naturblank

Bezeichnung	Bestellnummer	H	I	H	H	∅	CHF
Einlassgriff	13.1220/40	40	40	2	10	35	St 39.00
Einlassgriff	13.1220/50	50	50	2	10	45	St 42.00

**Möbelknopf Serie Parrot**

Eisen naturblank

Bezeichnung	Bestellnummer	H	H	Ø	CHF
Möbelknopf	13.1223/24	24	29	M4	St 19.00
Möbelknopf	13.1223/33	33	40	M4	St 22.00

**Möbelknopf Serie Zupò**

Eisen naturblank

Bezeichnung	Bestellnummer	H	H	Ø	CHF
Möbelknopf	13.1224/18	18	24	M4	St 18.00
Möbelknopf	13.1224/24	24	33	M4	St 21.00

**Möbelknopf Serie Besso**

Eisen naturblank

Bezeichnung	Bestellnummer	H	H	Ø	CHF
Möbelknopf	13.1225/30	30	27	M4	St 21.00
Möbelknopf	13.1225/35	35	27	M4	St 24.00

**Möbelknopf Serie Pollux**

Eisen naturblank

Bezeichnung	Bestellnummer	H	H	Ø	CHF
Möbelknopf	13.1226/20	20	25	M4	St 39.50
Möbelknopf	13.1226/30	30	30	M4	St 45.50

Knopf mit Rosette Serie Zinal

Eisen naturblank

Bezeichnung	Bestellnummer	H	I	H	Ø	----	CHF
Knopf mit Rosette	13.1227/15	20		27		M4	St 22.50
Knopf mit Rosette	13.1227/20	25		32		M4	St 26.00
Knopf mit Rosette	13.1227/25	30		37		M4	St 30.00
Rosette	13.1227/20 R	20	20	2	4.2		St 8.00
Rosette	13.1227/25 R	25	25	2	4.2		St 9.50
Rosette	13.1227/30 R	30	30	2	4.2		St 11.50

Möbelknopf Serie Zinal

Eisen naturblank

Bezeichnung	Bestellnummer	H	I	H	----	CHF	
Möbelknopf	13.1228/15	15	15	25		M4	St 14.50
Möbelknopf	13.1228/20	20	20	30		M4	St 16.50
Möbelknopf	13.1228/25	25	25	35		M4	St 18.50

Möbelknopf Serie Alv

Eisen naturblank

Bezeichnung	Bestellnummer	H	I	H	----	CHF	
Möbelknopf	13.1230/25	25	25	26		M4	St 28.00
Möbelknopf	13.1230/30	30	30	26		M4	St 31.00
Möbelknopf	13.1230/35	35	35	26		M4	St 34.50

Möbelknopf

Eisen naturblank

Bezeichnung	Bestellnummer	H	I	H	----	CHF	
Möbelknopf	13.1231/25	25	25	27		M4	St 34.50
Möbelknopf	13.1231/30	30	30	27		M4	St 40.50
Möbelknopf	13.1231/35	35	35	27		M4	St 46.00

Knopf mit Rosette Serie Spedia

Eisen naturblank

Bezeichnung	Bestellnummer	H	H	----	CHF	
Knopf mit Rosette	13.1233/20	20	27		M4	St 47.50
Knopf mit Rosette	13.1233/30	30	32		M4	St 57.00

Möbelknopf Serie Spedia

Eisen naturblank

Bezeichnung	Bestellnummer	H	I	H	----	CHF	
Möbelknopf	13.1234/20	20	20	25		M4	St 39.50
Möbelknopf	13.1234/30	30	30	35		M4	St 45.50

Möbelknopf

Eisen naturblank

Bezeichnung	Bestellnummer	H	H	----	CHF	
Möbelknopf	13.1235/18	18	30		M4	St 18.00
Möbelknopf	13.1235/22	22	30		M4	St 19.50

Möbelknopf

Eisen naturblank

Bezeichnung	Bestellnummer	H	H	----	CHF	
Möbelknopf	13.1236/20	20	23		M4	St 22.50
Möbelknopf	13.1236/25	25	26		M4	St 24.00
Möbelknopf	13.1236/30	30	26		M4	St 25.50



**Möbelknopf**

Eisen naturblank

Bezeichnung	Bestellnummer	H	H	Ø	CHF
Möbelknopf	13.1237/30	31	28	M4	St 35.50

**Möbelknopf**

Eisen naturblank

Bezeichnung	Bestellnummer	H	H	Ø	CHF
Möbelknopf	13.1238/15	15	20	M4	St 13.50
Möbelknopf	13.1238/20	20	22	M4	St 15.50
Möbelknopf	13.1238/25	25	25	M4	St 16.50
Möbelknopf	13.1238/30	30	30	M4	St 21.00
Möbelknopf	13.1238/35	35	35	M4	St 24.00

**Rosette**

Eisen naturblank

Bezeichnung	Bestellnummer	H	H	Ø	CHF
Rosette	13.1239/25 R	25	2	4.2	St 7.00
Rosette	13.1239/30 R	30	2	4.2	St 8.50
Rosette	13.1239/35 R	35	2	4.2	St 11.00

**Möbelknopf**

Eisen naturblank

Bezeichnung	Bestellnummer	H	H	Ø	CHF
Möbelknopf	13.1240/25	25	23	M4	St 21.00
Möbelknopf	13.1240/30	30	24	M4	St 21.00
Möbelknopf	13.1240/35	35	24	M4	St 21.50
Möbelknopf	13.1240/40	40	24	M4	St 24.00

**Rosette**

Eisen naturblank

Bezeichnung	Bestellnummer	H	H	Ø	CHF
Rosette	13.1241/25 R	25	2.5	4.2	St 7.50
Rosette	13.1241/30 R	30	3.5	4.2	St 12.00
Rosette	13.1241/40 R	40	4	4.2	St 16.50
Rosette	13.1241/50 R	50	4.5	4.2	St 19.50

**Knopf mit Rosette**

Eisen naturblank

Bezeichnung	Bestellnummer	H	H	H	Ø	Ø	CHF
Knopf mit Rosette	13.1245	50	28	30	M4		St 42.00
Rosette	13.1245/50 R	50	50	4	4.2		St 18.50

**Möbelknopf**

Eisen naturblank

Bezeichnung	Bestellnummer	H	H	Ø	CHF
Möbelknopf	13.1245/30 K	30	26	M4	St 23.50

**Knopf mit Rosette**

Eisen naturblank

Bezeichnung	Bestellnummer	H	H	Ø	Ø	CHF
Knopf mit Rosette	13.1246	65	35	40	M4	St 58.50
Rosette	13.1246/65 R	65	5	4.2		St 31.00





Möbelknopf

Eisen naturblank

Bezeichnung	Bestellnummer					CHF
Möbelknopf	13.1246/40 K	40	33	M4	St	27.50

Schrankolive Serie Zupò





Eisen naturblank

Bezeichnung	Bestellnummer						CHF
Schrankolive	13.429/55 E-35	55	33	7x35		St	64.00
Schrankknopf	13.429/55 F	55	31		M6	St	59.00

Zylinderolive Serie Alv

Eisen naturblank





ZA = Holzmontage / ZB = Combi Ferma/Steloc/Terza / GS = gleichschliessend / VS = verschiedenschliessend

Bezeichnung	Bestellnummer						CHF
Olive ohne Zylinder	13.430 ZA	50	50	43	7x44	St	196.50
Zylinderolive	13.430 ZA K8 GS	50	50	43	7x44	St	335.00
Zylinderolive	13.430 ZA K8 VS	50	50	43	7x44	St	335.00
Olive ohne Zylinder	13.430 ZB	50	50	43	7x44	St	196.50
Zylinderolive	13.430 ZB K8 GS	50	50	43	7x44	St	335.00
Zylinderolive	13.430 ZB K8 VS	50	50	43	7x44	St	335.00

Zylinder: Kaba 1008C/25





Schrankolive Serie Alv

Eisen naturblank

Bezeichnung	Bestellnummer							CHF
Schrankolive	13.430/50 E-35	50	50	33	7x35		St	64.00
Schrankknopf	13.430/50 F	50	50	31		M6	St	59.00





Schrankolive

Eisen naturblank

Bezeichnung	Bestellnummer							CHF
Schrankolive	13.431/50 E-35	50	50	32	7x35		St	72.50
Schrankknopf	13.431/50 F	50	50	30		M6	St	67.50





Schrankolive

Eisen naturblank

Bezeichnung	Bestellnummer							CHF
Schrankolive	13.432/85 E-35	90	58	32	7x35		St	62.00
Schrankknopf	13.432/85 F	90	58	30		M6	St	57.00

Schrankolive Serie Zinal

Eisen naturblank

Bezeichnung	Bestellnummer							CHF
Schrankolive	13.435 E-35	45	45	47	7x35		St	53.00
Schrankknopf	13.435 F	45	45	45		M6	St	48.00



**Zylinderolive**

Eisen naturblank

ZA = Holzmontage / ZB = Combi Ferma/Steloc/Terza / GS = gleichschliessend / VS = verschiedenschliessend

Bezeichnung	Bestellnummer	H	H	□	CHF
Olive ohne Zylinder	13.436 ZA	57	41	7x44	St 171.50
Zylinderolive	13.436 ZA K8 GS	57	41	7x44	St 310.00
Zylinderolive	13.436 ZA K8 VS	57	41	7x44	St 310.00
Olive ohne Zylinder	13.436 ZB	57	41	7x44	St 171.50
Zylinderolive	13.436 ZB K8 GS	57	41	7x44	St 310.00
Zylinderolive	13.436 ZB K8 VS	57	41	7x44	St 310.00

Zylinder: Kaba 1008C/25

**Schrankolive**

Eisen naturblank

Bezeichnung	Bestellnummer	H	H	□	mm	CHF
Schrankolive	13.458/45 E-35	45	40	7x35		St 52.00
Schrankknopf	13.458/45 F	45	38		M6	St 47.00
Schrankolive	13.458/55 E-35	55	44	7x35		St 55.00
Schrankknopf	13.458/55 F	55	42		M6	St 50.00

**Möbelschild**

Eisen naturblank

Bezeichnung	Bestellnummer	H	I	∞	CHF
Möbelschild	13.1134	38	119	64	St 26.00

**Möbelschild**

Eisen naturblank

Bezeichnung	Bestellnummer	H	I	∞	CHF
Möbelschild	13.1137	32	86	64	St 16.00

**Möbelschild**

Eisen naturblank

Bezeichnung	Bestellnummer	H	I	H	∞	CHF
Möbelschild	13.1260/070	21	70	2	63	St 25.00
Möbelschild	13.1260/090	26	90	2	80	St 25.00
Möbelschild blind	13.1260/090 BL	26	90	2	80	St 25.00
Möbelschild	13.1260/110	31	110	2	100	St 31.50
Möbelschild blind	13.1260/110 BL	31	110	2	100	St 31.50
Möbelschild	13.1260/135	39	135	2	120	St 37.00

**Möbelschild**

Eisen naturblank

Bezeichnung	Bestellnummer	H	I	H	∞	CHF
Möbelschild	13.1261/090	90	26	2	80	St 25.00

Möbelschild

Eisen naturblank

Bezeichnung	Bestellnummer	H	I	H	∞	CHF
Möbelschild	13.1262	20	90	2	52	St 17.50



Möbelschild

Eisen naturblank

Bezeichnung	Bestellnummer	H	I	H	∞	CHF
Möbelschild	13.1276	25	110	2	95	St 31.00



Möbelschild

Eisen naturblank

Bezeichnung	Bestellnummer	H	I	H	∞	CHF
Möbelschild	13.1278	40	100	2	80	St 24.50



Möbelschild

Eisen naturblank

Bezeichnung	Bestellnummer	H	I	H	∞	CHF
Möbelschild	13.1280/60	35	60	2	41	St 20.50
Möbelschild	13.1280/90	45	90	2	66	St 26.00



Möbelschild

Eisen naturblank

Bezeichnung	Bestellnummer	H	I	H	∅	∞	CHF
Möbelschild	13.1280/60 R-4.2mm	35	60	2	4.2	41	St 20.50
Möbelschild	13.1280/90 R-4.2mm	45	90	2	4.2	66	St 26.00



Möbelschild

Eisen naturblank

Bezeichnung	Bestellnummer	H	I	H	∞	CHF
Möbelschild	13.1282	40	80	2	59	St 31.00



Möbelschild

Eisen naturblank

Bezeichnung	Bestellnummer	H	I	H	∅	∞	CHF
Möbelschild	13.1282 R-4.2mm	40	80	2	4.2	59	St 31.00

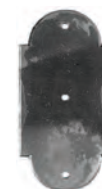

**Möbelschild**

Eisen naturblank

Bezeichnung	Bestellnummer	H	I	H	CHF
Möbelschild	13.1285	55	65	2	St 21.00

**Möbelschild**

Eisen naturblank

Bezeichnung	Bestellnummer	H	I	H	∞	CHF
Möbelschild	13.1289	37	175	4	90	St 42.00

**Möbelschild mit Ring**

Eisen naturblank

Bezeichnung	Bestellnummer	H	I	H	∞	CHF
Möbelschild mit Ring	13.1291	50	160	30	91	St 120.50

**Möbelschild**

Eisen naturblank

Bezeichnung	Bestellnummer	H	I	H	∞	CHF
Möbelschild	13.1292	37	165	2	133	St 30.00

Möbelschild

Eisen naturblank

Bezeichnung	Bestellnummer	H	I	H	∞	CHF
Möbelschild	13.1295/050	20	54	2	42	St 18.00
Möbelschild	13.1295/100	25	100	2	87	St 19.50



Möbelschild

Eisen naturblank

Bezeichnung	Bestellnummer	H	I	H	∅	∞	CHF
Möbelschild	13.1295/050 R-4.2mm	20	54	2	4.2	42	St 18.00



Möbelschild

Eisen naturblank

Bezeichnung	Bestellnummer	H	I	H	∞	CHF
Möbelschild	13.1299	25	66	3	53	St 22.00



Möbelschild

Eisen naturblank

Bezeichnung	Bestellnummer	H	I	H	∞	CHF
Möbelschild	13.1301/30	30	30	3	19	St 18.50
Möbelschild	13.1301/35	35	35	3	23	St 20.50



Truhenschild

Eisen naturblank

Bezeichnung	Bestellnummer	H	I	H	CHF
Truhenschild	13.1755	60	80	4	St 30.00



Truhenschild

Eisen naturblank

Bezeichnung	Bestellnummer	H	I	H	CHF
Truhenschild	13.1757	75	90	2	St 59.50



Schlüsselkopf

Eisen naturblank

Bezeichnung	Bestellnummer	H	I	∅	CHF
Schlüsselkopf	13.1500	30	30	4.2	St 30.00



Schlüsselkopf

Eisen naturblank

Bezeichnung	Bestellnummer	H	I	∅	CHF
Schlüsselkopf	13.1506	28	40	5.2	St 25.00



**Schlüsselkopf**

Eisen naturblank

Bezeichnung	Bestellnummer	H	I	Ø		CHF
Schlüsselkopf	13.1510/26	26	27	5.2	St	30.50
Schlüsselkopf	13.1510/32	32	31	7.2	St	32.00
Schlüsselkopf	13.1510/36	36	38	7.2	St	34.00
Schlüsselkopf	13.1510/40	46	48	10.2	St	39.50

**Möbelband**Eisen naturblank
flach

Bezeichnung	Bestellnummer	H	I	Ø		CHF
Möbelband links	13.1185/060 Ls	45	95	8	St	32.50
Möbelband rechts	13.1185/060 Rs	45	95	8	St	32.50
Möbelband links	13.1185/080 Ls	50	122	9	St	34.50
Möbelband rechts	13.1185/080 Rs	50	122	9	St	34.50
Möbelband links	13.1185/100 Ls	55	150	10	St	38.00
Möbelband rechts	13.1185/100 Rs	55	150	10	St	38.00

**Möbelband**Eisen naturblank
Kröpfung D 7.5 mm

Bezeichnung	Bestellnummer	H	I	Ø		CHF
Möbelband links	13.1186/050 Ls	50	90	7	St	29.50
Möbelband rechts	13.1186/050 Rs	50	90	7	St	29.50
Möbelband links	13.1186/060 Ls	50	105	8	St	32.00
Möbelband rechts	13.1186/060 Rs	50	105	8	St	32.00
Möbelband links	13.1186/080 Ls	50	132	9	St	33.00
Möbelband rechts	13.1186/080 Rs	50	132	9	St	33.00
Möbelband links	13.1186/100 Ls	50	162	10	St	35.00
Möbelband rechts	13.1186/100 Rs	50	162	10	St	35.00

**Möbelband**Eisen naturblank
Kröpfung D 7.5 mm

Bezeichnung	Bestellnummer	H	I	Ø		CHF
Möbelband links	13.1188/050 Ls	50	80	7	St	29.50
Möbelband rechts	13.1188/050 Rs	50	80	7	St	29.50
Möbelband links	13.1188/060 Ls	50	95	8	St	32.00
Möbelband rechts	13.1188/060 Rs	50	95	8	St	32.00
Möbelband links	13.1188/080 Ls	50	120	9	St	33.00
Möbelband rechts	13.1188/080 Rs	50	120	9	St	33.00
Möbelband links	13.1188/100 Ls	50	150	10	St	35.00
Möbelband rechts	13.1188/100 Rs	50	150	10	St	35.00

Kreuzband mit Plattenstützkloben

Eisen naturblank

Bezeichnung	Bestellnummer	H	I	TR	Ø	≠	CHF
Kreuzband mit Plattenstützkloben	13.1200/078 B1				5	12	St 67.50
Kreuzband mit Plattenstützkloben	13.1200/100 B2				6	12	St 73.00
Kreuzband mit Plattenstützkloben	13.1200/120 B3				6	12	St 75.50
Kreuzband mit Plattenstützkloben	13.1200/135 B4				7	12	St 84.00
Kreuzband ohne Kloben	13.1200/078	44	78		5		St 36.50
Kreuzband ohne Kloben	13.1200/100	58	100		6		St 39.50
Kreuzband ohne Kloben	13.1200/120	66	120		6		St 42.00
Kreuzband ohne Kloben	13.1200/135	80	135		7		St 47.50
Plattenstützkloben	13.1200 B1	16	82	51	5	12	St 31.00
Plattenstützkloben	13.1200 B2	20	95	52	6	12	St 33.50
Plattenstützkloben	13.1200 B3	22	108	61	6	12	St 33.50
Plattenstützkloben	13.1200 B4	22	120	66	7	12	St 36.50

**Kreuzband mit Bolzenstützkloben**

Eisen naturblank

Bezeichnung	Bestellnummer	H	I	Ø	≠	CHF
Kreuzband mit Bolzenstützkloben	13.1200/078 D1			5	12	St 55.00
Kreuzband mit Bolzenstützkloben	13.1200/100 D2			6	12	St 59.50
Kreuzband mit Bolzenstützkloben	13.1200/120 D3			6	12	St 62.00
Kreuzband mit Bolzenstützkloben	13.1200/135 D4			7	12	St 69.50
Kreuzband ohne Kloben	13.1200/078	44	78	5		St 36.50
Kreuzband ohne Kloben	13.1200/100	58	100	6		St 39.50
Kreuzband ohne Kloben	13.1200/120	66	120	6		St 42.00
Kreuzband ohne Kloben	13.1200/135	80	135	7		St 47.50
Bolzenstützkloben	13.1200 D1	9	80	5	12	St 18.50
Bolzenstützkloben	13.1200 D2	13	95	6	12	St 20.00
Bolzenstützkloben	13.1200 D3	14	108	6	12	St 20.00
Bolzenstützkloben	13.1200 D4	16	120	7	12	St 22.00

**Schrankband mit Kloben**

Eisen naturblank

Bezeichnung	Bestellnummer	H	I	TR	Ø	≠	CHF
Schrankband mit Bolzenstützkloben	13.1202/195 D 12mm				8	12	St 105.50
Schrankband mit Bolzenstützkloben	13.1202/195 D 15mm				8	15	St 105.50
Schrankband mit Plattenstützkloben	13.1202/195 B 12mm				8	12	St 120.50
Schrankband mit Plattenstützkloben	13.1202/195 B 15mm				8	15	St 120.50
Schrankband ohne Kloben	13.1202/195 12mm	83	195		8	12	St 74.50
Schrankband ohne Kloben	13.1202/195 15mm	83	195		8	15	St 74.50
Bolzenstützkloben	13.1202 D	16	125		8	12/15	St 31.00
Plattenstützkloben	13.1202 B	25	125	72	8	12/15	St 46.00



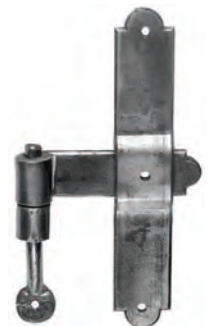
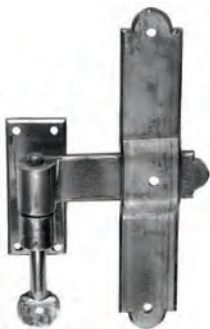

Kreuzband mit Plattenstützkloben

Eisen naturblank

Bezeichnung	Bestellnummer	H	I	IR	Ø	≠	CHF
Kreuzband mit Plattenstützkloben	13.1208/100 B1				6	12	St 78.00
Kreuzband mit Plattenstützkloben	13.1208/140 B2				7	12	St 86.00
Schrankband mit Plattenstützkloben	13.1208/180 B3				8	15	St 107.00
Plattenstützkloben	13.1208 B1	20	83	56	6	12	St 32.00
Plattenstützkloben	13.1208 B2	24	94	62	7	12	St 34.00
Plattenstützkloben	13.1208 B3	26	101	70	8	15	St 43.50

Kreuzband mit Bolzenstützkloben

Eisen naturblank

Bezeichnung	Bestellnummer	H	I	Ø	≠	CHF
Kreuzband mit Bolzenstützkloben	13.1208/100 D1			6	12	St 65.50
Kreuzband mit Bolzenstützkloben	13.1208/140 D2			7	12	St 73.00
Schrankband mit Bolzenstützkloben	13.1208/180 D3			8	15	St 93.50
Kreuzband ohne Kloben	13.1208/100	73	100	6		St 46.00
Kreuzband ohne Kloben	13.1208/140	78	140	7		St 52.00
Schrankband ohne Kloben	13.1208/180	98	180	8		St 63.50
Bolzenstützkloben	13.1208 D1	15	76	6	12	St 19.50
Bolzenstützkloben	13.1208 D2	16	94	7	12	St 21.00
Bolzenstützkloben	13.1208 D3	16	101	8	15	St 30.00

Möbellangband mit Kloben

Eisen naturblank

Bezeichnung	Bestellnummer	H	I	IR	Ø	≠	CHF
Möbellangband mit Bolzenstützkloben	13.1210/200 D1				7	12	St 61.50
Möbellangband mit Bolzenstützkloben	13.1210/300 D2				8	12	St 68.50
Möbellangband mit Bolzenstützkloben	13.1210/400 D3				8	12	St 78.00
Möbellangband mit Bolzenstützkloben	13.1210/500 D3				8	12	St 85.00
Möbellangband mit Plattenstützkloben	13.1210/200 B1				7	12	St 72.00
Möbellangband mit Plattenstützkloben	13.1210/300 B2				8	12	St 86.00
Möbellangband mit Plattenstützkloben	13.1210/400 B3				8	12	St 95.50
Möbellangband mit Plattenstützkloben	13.1210/500 B3				8	12	St 102.50
Möbellangband ohne Kloben	13.1210/200	210	35	7		St 37.00	
Möbellangband ohne Kloben	13.1210/300	310	43	8		St 42.50	
Möbellangband ohne Kloben	13.1210/400	410	43	8		St 52.00	
Möbellangband ohne Kloben	13.1210/500	510	43	8		St 59.00	
Bolzenstützkloben	13.1210 D1	20	132	7	12	St 24.50	
Bolzenstützkloben	13.1210 D2	20	138	8	12	St 26.00	
Bolzenstützkloben	13.1210 D3	20	138	8	12	St 26.00	
Plattenstützkloben	13.1210 B1	20	118	66	7	12	St 35.00
Plattenstützkloben	13.1210 B2	25	138	82	8	12	St 43.50
Plattenstützkloben	13.1210 B3	25	138	82	8	12	St 43.50

Buffetband

Eisen naturblank

Bezeichnung	Bestellnummer	H	I	H	CHF
Buffetband	13.1212/175	240	28	25	St 81.50

**Buffetband**

Eisen naturblank

Bezeichnung	Bestellnummer	H	I	H	CHF
Buffetband	13.1213/250	320	28	30	St 99.50

**Schrankband**

Eisen naturblank

Bezeichnung	Bestellnummer	H	I	H	CHF
Schrankband	13.1214/450	520	50	40	St 141.50

**Truhenband innen**

Eisen naturblank

Bezeichnung	Bestellnummer	H	I	H	CHF
Truhenband innen	13.1741/300	430	43	30	St 89.50

**Ueberfalle**

Eisen naturblank

Bezeichnung	Bestellnummer	H	I	CHF
Ueberfalle	13.1768/140	50	250	St 136.00

**Buffetschloss**

Eisen naturblank

Bezeichnung	Bestellnummer	H	I	H	I	CHF
Buffetschloss links	13.1112/30 Ls	70	75	30	30	St 340.00
Buffetschloss rechts	13.1112/30 Rs	70	75	30	30	St 340.00
Buffetschloss links	13.1112/35 Ls	75	75	30	35	St 340.00
Buffetschloss rechts	13.1112/35 Rs	75	75	30	35	St 340.00

**Schrankschloss**

Eisen naturblank

Bezeichnung	Bestellnummer	H	I	H	I	CHF
Schrankschloss links	13.1121/30 Ls	125	80	30	30	St 212.00
Schrankschloss rechts	13.1121/30 Rs	125	80	30	30	St 212.00
Schrankschloss links	13.1121/35 Ls	130	80	30	35	St 212.00
Schrankschloss rechts	13.1121/35 Rs	130	80	30	35	St 212.00
Schrankschloss links	13.1121/40 Ls	135	80	30	40	St 212.00
Schrankschloss rechts	13.1121/40 Rs	135	80	30	40	St 212.00
Schrankschloss links	13.1121/45 Ls	140	80	30	45	St 212.00
Schrankschloss rechts	13.1121/45 Rs	140	80	30	45	St 212.00
Schrankschloss links	13.1121/50 Ls	145	80	30	50	St 212.00
Schrankschloss rechts	13.1121/50 Rs	145	80	30	50	St 212.00
Schrankschloss links	13.1121/60 Ls	155	80	30	60	St 212.00
Schrankschloss rechts	13.1121/60 Rs	155	80	30	60	St 212.00



**Schliessblech**

Eisen naturblank

Bezeichnung	Bestellnummer	H	I	H	CHF
Schliessblech	13.1125 S-Blech	25	45	5	St 10.00

passend zu Schloss Nr. 13.1121 + 13.1125

**Buffetschloss**

Eisen naturblank

Bezeichnung	Bestellnummer	H	I	H	I	CHF
Schlüssel	13.1125 S					St 18.50
Buffetschloss links	13.1125/25 Ls	80	55	20	25	St 174.00
Buffetschloss rechts	13.1125/25 Rs	80	55	20	25	St 174.00
Buffetschloss links	13.1125/30 Ls	80	55	20	30	St 174.00
Buffetschloss rechts	13.1125/30 Rs	80	55	20	30	St 174.00
Buffetschloss links	13.1125/35 Ls	80	60	20	35	St 174.00
Buffetschloss rechts	13.1125/35 Rs	80	60	20	35	St 174.00
Buffetschloss links	13.1125/40 Ls	80	60	20	40	St 174.00
Buffetschloss rechts	13.1125/40 Rs	80	60	20	40	St 174.00
Buffetschloss links	13.1125/45 Ls	95	70	20	45	St 174.00
Buffetschloss rechts	13.1125/45 Rs	95	70	20	45	St 174.00
Buffetschloss links	13.1125/50 Ls	95	70	20	50	St 174.00
Buffetschloss rechts	13.1125/50 Rs	95	70	20	50	St 174.00
Buffetschloss links	13.1125/55 Ls	95	70	20	55	St 174.00
Buffetschloss rechts	13.1125/55 Rs	95	70	20	55	St 174.00
Buffetschloss links	13.1125/60 Ls	110	75	20	60	St 174.00
Buffetschloss rechts	13.1125/60 Rs	110	75	20	60	St 174.00

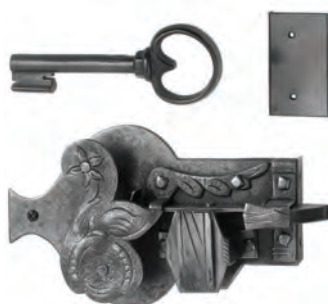
**Buffetschloss**

Eisen naturblank

offenes Schnappriegelschloss für Buffets und Kästen (ca.1590-1750)

Bezeichnung	Bestellnummer	H	I	H	I	CHF
Buffetschloss links	13.1130/25 Ls	100	72	15	25	St 181.00
Buffetschloss rechts	13.1130/25 Rs	100	72	15	25	St 181.00
Buffetschloss links	13.1130/30 Ls	105	72	15	30	St 181.00
Buffetschloss rechts	13.1130/30 Rs	105	72	15	30	St 181.00
Buffetschloss links	13.1130/35 Ls	125	80	15	35	St 181.00
Buffetschloss rechts	13.1130/35 Rs	125	80	15	35	St 181.00
Buffetschloss links	13.1130/40 Ls	130	80	15	40	St 181.00
Buffetschloss rechts	13.1130/40 Rs	130	80	15	40	St 181.00
Buffetschloss links	13.1130/45 Ls	135	80	15	45	St 181.00
Buffetschloss rechts	13.1130/45 Rs	135	80	15	45	St 181.00
Buffetschloss links	13.1130/50 Ls	140	80	15	50	St 181.00
Buffetschloss rechts	13.1130/50 Rs	140	80	15	50	St 181.00
Buffetschloss links	13.1130/55 Ls	145	80	15	55	St 181.00
Buffetschloss rechts	13.1130/55 Rs	145	80	15	55	St 181.00
Schlüssel	13.1130 S					St 19.50







**Truhenschloss**

Eisen naturblank

Bezeichnung	Bestellnummer	H	I	H	I	CHF
Schliesskloben	13.1759 S-Kloben	20	60	37		St 19.00
Truhenschloss	13.1759/060	80	120	36	60	St 165.00
Truhenschloss	13.1759/070	80	130	36	70	St 165.00
Truhenschloss	13.1759/080	80	140	36	80	St 165.00
Truhenschloss	13.1759/090	80	150	36	90	St 165.00
Truhenschloss	13.1759/100	80	160	36	100	St 165.00
Truhenschloss	13.1759/110	80	165	36	110	St 165.00





Bügelgriff Serie Zinal

Eisen verzinkt-altpatiniert

Bezeichnung	Bestellnummer								CHF
Bügelgriff	15.1252/096	104	8	28	96	8	M4	St	45.50
Bügelgriff	15.1252/128	136	8	28	128	8	M4	St	50.50
Bügelgriff	15.1252/160	170	10	32	160	10	M4	St	54.50





**Bügelgriff Serie Alv**

Eisen verzinkt-altpatiniert

Bezeichnung	Bestellnummer						CHF
Bügelgriff	15.1256/096	106	15	36	96	M4	St 59.00
Bügelgriff	15.1256/128	138	15	36	128	M4	St 63.00
Bügelgriff	15.1256/160	170	15	36	160	M4	St 66.00
Bügelgriff	15.1256/448	458	15	36	448	M5	St 103.00





**Bügelgriff Serie Pollux**

Eisen verzinkt-altpatiniert

Bezeichnung	Bestellnummer						CHF
Bügelgriff	15.1350/096	106	14	32	96	M4	St 47.50
Bügelgriff	15.1350/128	138	14	32	128	M4	St 52.50





**Bügelgriff Serie Zupò**

Eisen verzinkt-altpatiniert

Bezeichnung	Bestellnummer						CHF
Bügelgriff	15.1351/096	106	10	34	96	M4	St 45.50
Bügelgriff	15.1351/128	138	10	34	128	M4	St 50.50
Bügelgriff	15.1351/160	170	10	34	160	M4	St 54.50
Bügelgriff	15.1351/192	202	10	34	192	M4	St 58.00



**Bügelgriff Serie Spedia**

Eisen verzinkt-altpatiniert

Bezeichnung	Bestellnummer						CHF
Bügelgriff	15.1352/096	106	14	32	96	M4	St 47.50
Bügelgriff	15.1352/128	138	14	32	128	M4	St 52.50
Bügelgriff	15.1352/160	170	14	32	160	M4	St 56.50
Bügelgriff	15.1352/192	202	14	32	192	M4	St 61.00

**Möbelknopf Serie Zupò**

Eisen verzinkt-altpatiniert

Bezeichnung	Bestellnummer				CHF
Möbelknopf	15.1224/18	18	24	M4	St 25.50
Möbelknopf	15.1224/24	24	33	M4	St 28.50

**Möbelknopf Serie Pollux**

Eisen verzinkt-altpatiniert

Bezeichnung	Bestellnummer				CHF
Möbelknopf	15.1226/20	20	25	M4	St 47.00
Möbelknopf	15.1226/30	30	30	M4	St 53.00

**Möbelknopf Serie Zinal**

Eisen verzinkt-altpatiniert

Bezeichnung	Bestellnummer					CHF
Möbelknopf	15.1228/20	20	20	30	M4	St 24.00
Möbelknopf	15.1228/25	25	25	35	M4	St 26.00



**Möbelknopf Serie Alv**

Eisen verzinkt-altpatiniert

Bezeichnung	Bestellnummer	H	I	H	mm	CHF
Möbelknopf	15.1230/25	25	25	26	M4	St 35.50
Möbelknopf	15.1230/30	30	30	26	M4	St 38.50
Möbelknopf	15.1230/35	35	35	26	M4	St 42.00

**Möbelknopf Serie Spedia**

Eisen verzinkt-altpatiniert

Bezeichnung	Bestellnummer	H	I	H	mm	CHF
Möbelknopf	15.1234/20	20	20	25	M4	St 47.00
Möbelknopf	15.1234/30	30	30	35	M4	St 53.00

**Zylinderolive Serie Alv**

Eisen verzinkt-altpatiniert

ZA = Holzmontage / ZB = Combi Ferma/Steloc/Terza / GS = gleichschliessend / VS = verschiedenschliessend

Bezeichnung	Bestellnummer	H	I	H	mm	CHF
Olive ohne Zylinder	15.430 ZA	50	50	43	7x44	St 206.50
Zylinderolive	15.430 ZA K8 GS	50	50	43	7x44	St 345.00
Zylinderolive	15.430 ZA K8 VS	50	50	43	7x44	St 345.00
Olive ohne Zylinder	15.430 ZB	50	50	43	7x44	St 206.50
Zylinderolive	15.430 ZB K8 GS	50	50	43	7x44	St 345.00
Zylinderolive	15.430 ZB K8 VS	50	50	43	7x44	St 345.00

Zylinder: Kaba 1008C/25

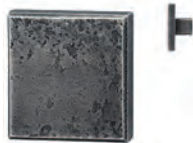
**Schrankolive Serie Alv**

Eisen verzinkt-altpatiniert

Bezeichnung	Bestellnummer	H	I	H	mm	CHF
Schrankolive	15.430/50 E-35	50	50	33	7x35	St 76.50
Schrankknopf	15.430/50 F	50	50	31	M6	St 71.50

**Möbelschild**

Eisen verzinkt-altpatiniert

Bezeichnung	Bestellnummer	H	I	H	mm	CHF
Möbelschild	15.1301/30	30	30	3	19	St 24.00
Möbelschild	15.1301/35	35	35	3	23	St 26.00

Bügelgriff

Eisen gerostet

Bezeichnung	Bestellnummer	H	I	H	∞	CHF
Bügelgriff	16.1250/120	120	18	37	87	St 48.00
Bügelgriff	16.1250/150	150	18	39	117	St 49.50

Bügelgriff Serie Zinal

Eisen gerostet

Bezeichnung	Bestellnummer	H	I	H	∞	≠	▨	CHF
Bügelgriff	16.1252/096	104	8	28	96	8	M4	St 45.50
Bügelgriff	16.1252/128	136	8	28	128	8	M4	St 50.50
Bügelgriff	16.1252/160	170	10	32	160	10	M4	St 54.50

Bügelgriff Serie Alv

Eisen gerostet

Bezeichnung	Bestellnummer	H	I	H	∞	▨	CHF
Bügelgriff	16.1256/096	106	15	36	96	M4	St 59.00
Bügelgriff	16.1256/128	138	15	36	128	M4	St 63.00
Bügelgriff	16.1256/160	170	15	36	160	M4	St 66.00

Bügelgriff Serie Zinal

Eisen gerostet

Bezeichnung	Bestellnummer	H	H	∞	∞	▨	CHF
Bügelgriff	16.1257/096	108	35	12	96	M4	St 46.50
Bügelgriff	16.1257/128	140	35	12	128	M4	St 51.50
Bügelgriff	16.1257/160	172	35	12	160	M4	St 55.50

Bügelgriff Serie Pollux

Eisen gerostet

Bezeichnung	Bestellnummer	H	I	H	∞	▨	CHF
Bügelgriff	16.1350/096	106	14	32	96	M4	St 47.50
Bügelgriff	16.1350/128	138	14	32	128	M4	St 52.50

Bügelgriff Serie Zupò

Eisen gerostet

Bezeichnung	Bestellnummer	H	I	H	∞	▨	CHF
Bügelgriff	16.1351/096	106	10	34	96	M4	St 45.50
Bügelgriff	16.1351/128	138	10	34	128	M4	St 50.50
Bügelgriff	16.1351/160	170	10	34	160	M4	St 54.50
Bügelgriff	16.1351/192	202	10	34	192	M4	St 58.00

Bügelgriff Serie Spedia

Eisen gerostet

Bezeichnung	Bestellnummer	H	I	H	∞	▨	CHF
Bügelgriff	16.1352/096	106	14	32	96	M4	St 47.50
Bügelgriff	16.1352/128	138	14	32	128	M4	St 52.50
Bügelgriff	16.1352/160	170	14	32	160	M4	St 56.50
Bügelgriff	16.1352/192	202	14	32	192	M4	St 61.00

Einlassgriff

Eisen gerostet

Bezeichnung	Bestellnummer	H	H	H	∅	CHF
Einlassgriff	16.1218/40	40	2	10	30	St 51.50
Einlassgriff	16.1218/50	50	2	10	40	St 54.50

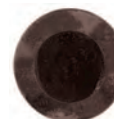

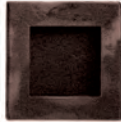
**Einlassgriff**

Eisen gerostet

Bezeichnung	Bestellnummer	H	I	H	H	Ø		CHF
Einlassgriff	16.1220/40	40	40	2	10	35	St	51.50
Einlassgriff	16.1220/50	50	50	2	10	45	St	54.50

**Möbelknopf Serie Parrot**

Eisen gerostet

Bezeichnung	Bestellnummer	H	H	Ø		CHF
Möbelknopf	16.1223/24	24	29	M4	St	26.50
Möbelknopf	16.1223/33	33	40	M4	St	29.50

**Möbelknopf Serie Zupò**

Eisen gerostet

Bezeichnung	Bestellnummer	H	H	Ø		CHF
Möbelknopf	16.1224/18	18	24	M4	St	25.50
Möbelknopf	16.1224/24	24	33	M4	St	28.50

**Möbelknopf Serie Pollux**

Eisen gerostet

Bezeichnung	Bestellnummer	H	H	Ø		CHF
Möbelknopf	16.1226/20	20	25	M4	St	47.00
Möbelknopf	16.1226/30	30	30	M4	St	53.00

**Knopf mit Rosette Serie Zinal**

Eisen gerostet

Bezeichnung	Bestellnummer	H	I	H	Ø	Ø		CHF
Knopf mit Rosette	16.1227/20	25		32		M4	St	39.00
Knopf mit Rosette	16.1227/25	30		37		M4	St	43.00
Rosette	16.1227/20 R	20	20	2	4.2		St	13.50
Rosette	16.1227/25 R	25	25	2	4.2		St	15.00
Rosette	16.1227/30 R	30	30	2	4.2		St	17.00

**Möbelknopf Serie Zinal**

Eisen gerostet

Bezeichnung	Bestellnummer	H	I	H	Ø		CHF
Möbelknopf	16.1228/20	20	20	30	M4	St	24.00
Möbelknopf	16.1228/25	25	25	35	M4	St	26.00

**Möbelknopf Serie Alv**

Eisen gerostet

Bezeichnung	Bestellnummer	H	I	H	Ø		CHF
Möbelknopf	16.1230/25	25	25	26	M4	St	35.50
Möbelknopf	16.1230/30	30	30	26	M4	St	38.50
Möbelknopf	16.1230/35	35	35	26	M4	St	42.00

**Knopf mit Rosette Serie Spedia**

Eisen gerostet

Bezeichnung	Bestellnummer	H	H	Ø		CHF
Knopf mit Rosette	16.1233/20	20	27	M4	St	60.50
Knopf mit Rosette	16.1233/30	30	37	M4	St	70.00



Möbelknopf Serie Spedia

Eisen gerostet

Bezeichnung	Bestellnummer					CHF
Möbelknopf	16.1234/20	20	20	25	M4	St 47.00
Möbelknopf	16.1234/30	30	30	35	M4	St 53.00



Möbelknopf

Eisen gerostet

Bezeichnung	Bestellnummer				CHF
Möbelknopf	16.1236/20	20	23	M4	St 30.00
Möbelknopf	16.1236/25	25	26	M4	St 31.50
Möbelknopf	16.1236/30	30	26	M4	St 33.00



Möbelknopf

Eisen gerostet

Bezeichnung	Bestellnummer				CHF
Möbelknopf	16.1238/20	20	22	M4	St 23.00
Möbelknopf	16.1238/25	25	25	M4	St 24.00
Möbelknopf	16.1238/30	30	30	M4	St 28.50
Möbelknopf	16.1238/35	35	35	M4	St 31.50

Schrankolive Serie Zupò





Eisen gerostet

Bezeichnung	Bestellnummer					CHF
Schrankolive	16.429/55 E-35	55	33	7x35		St 76.50
Schrankknopf	16.429/55 F	55	31		M6	St 71.50

Zylinderolive Serie Alv

Eisen gerostet





ZA = Holzmontage / ZB = Combi Ferma/Steloc/Terza / GS = gleichschliessend / VS = verschiedenschliessend

Bezeichnung	Bestellnummer					CHF
Olive ohne Zylinder	16.430 ZA	50	50	43	7x44	St 216.50
Zylinderolive	16.430 ZA K8 GS	50	50	43	7x44	St 355.00
Zylinderolive	16.430 ZA K8 VS	50	50	43	7x44	St 355.00
Olive ohne Zylinder	16.430 ZB	50	50	43	7x44	St 216.50
Zylinderolive	16.430 ZB K8 GS	50	50	43	7x44	St 355.00
Zylinderolive	16.430 ZB K8 VS	50	50	43	7x44	St 355.00

Zylinder: Kaba 1008C/25

Schrankolive Serie Alv

Eisen gerostet

Bezeichnung	Bestellnummer						CHF
Schrankolive	16.430/50 E-35	50	50	33	7x35		St 76.50
Schrankknopf	16.430/50 F	50	50	31		M6	St 71.50

Schrankolive Serie Zinal

Eisen gerostet

Bezeichnung	Bestellnummer						CHF
Schrankolive	16.435 E-35	45	45	47	7x35		St 65.50
Schrankknopf	16.435 F	45	45	45		M6	St 60.50



**Zylinderolive**

Eisen gerostet

ZA = Holzmontage / ZB = Combi Ferma/Steloc/Terza / GS = gleichschliessend / VS = verschiedenschliessend

Bezeichnung	Bestellnummer	H	H	∅	CHF
Olive ohne Zylinder	16.436 ZA	57	41	7x44	St 191.50
Zylinderolive	16.436 ZA K8 GS	57	41	7x44	St 330.00
Zylinderolive	16.436 ZA K8 VS	57	41	7x44	St 330.00
Olive ohne Zylinder	16.436 ZB	57	41	7x44	St 191.50
Zylinderolive	16.436 ZB K8 GS	57	41	7x44	St 330.00
Zylinderolive	16.436 ZB K8 VS	57	41	7x44	St 330.00

Zylinder: Kaba 1008C/25

**Schränkolive**

Eisen gerostet

Bezeichnung	Bestellnummer	H	H	∅	mm	CHF
Schränkolive	16.458/45 E-35	45	40	7x35		St 63.00
Möbelknopf	16.458/45 F	45	38		M6	St 58.00
Schränkolive	16.458/55 E-35	55	44	7x35		St 67.50
Schränknopf	16.458/55 F	55	42		M6	St 62.50

**Möbelschild**

Eisen gerostet

Bezeichnung	Bestellnummer	H	I	H	∅	CHF
Möbelschild	16.1260/090	26	90	2	80	St 32.50

**Möbelschild**

Eisen gerostet

Bezeichnung	Bestellnummer	H	I	H	∅	CHF
Möbelschild	16.1276	25	110	2	95	St 39.00

**Möbelschild**

Eisen gerostet

Bezeichnung	Bestellnummer	H	I	H	∅	CHF
Möbelschild	16.1280/60	35	60	2	41	St 27.50

**Möbelschild**

Eisen gerostet

Bezeichnung	Bestellnummer	H	I	H	∅	∅	CHF
Möbelschild	16.1280/60 R-4.2mm	35	60	2	4.2	41	St 27.50

Möbelschild

Eisen gerostet

Bezeichnung	Bestellnummer	H	I	H	∞	CHF
Möbelschild	16.1295/050	20	54	2	42	St 24.00
Möbelschild	16.1295/100	25	100	2	87	St 26.50

Möbelschild

Eisen gerostet

Bezeichnung	Bestellnummer	H	I	H	∞	CHF
Möbelschild	16.1299	25	66	3	53	St 29.00

Möbelschild

Eisen gerostet

Bezeichnung	Bestellnummer	H	I	H	∞	CHF
Möbelschild	16.1301/30	30	30	3	19	St 24.00
Möbelschild	16.1301/35	35	35	3	23	St 26.00

Schlüsselkopf

Eisen gerostet

Bezeichnung	Bestellnummer	H	I	∅	CHF
Schlüsselkopf	16.1159.1	25	30	4.2	St 19.50
Schlüsselkopf	16.1159.2	29	32	4.2	St 19.50

Schlüsselkopf

Eisen gerostet

Bezeichnung	Bestellnummer	H	I	∅	CHF
Schlüsselkopf	16.1168	30	36	4.2	St 19.50

Schlüsselkopf

Eisen gerostet

Bezeichnung	Bestellnummer	H	I	∅	CHF
Schlüsselkopf	16.1500	30	30	4.2	St 35.50





Kreuzband mit Bolzenstützkloben

Eisen gerostet

Bezeichnung	Bestellnummer	H	I	∅	≠	CHF
Kreuzband mit Bolzenstützkloben	16.1200/078 D1			5	12	St 76.50
Kreuzband mit Bolzenstützkloben	16.1200/100 D2			6	12	St 81.00
Kreuzband mit Bolzenstützkloben	16.1200/120 D3			6	12	St 83.50
Kreuzband mit Bolzenstützkloben	16.1200/135 D4			7	12	St 92.50
Kreuzband ohne Kloben	16.1200/078	44	78	5		St 47.50
Kreuzband ohne Kloben	16.1200/100	58	100	6		St 50.50
Kreuzband ohne Kloben	16.1200/120	66	120	6		St 53.00
Kreuzband ohne Kloben	16.1200/135	80	135	7		St 60.00
Bolzenstützkloben	16.1200 D1	9	80	5	12	St 29.00
Bolzenstützkloben	16.1200 D2	13	95	6	12	St 30.50
Bolzenstützkloben	16.1200 D3	14	108	6	12	St 30.50
Bolzenstützkloben	16.1200 D4	16	120	7	12	St 32.50



Schrankband mit Kloben

Eisen gerostet

Bezeichnung	Bestellnummer	H	I	TR	∅	≠	CHF
Schrankband mit Plattenstützkloben	16.1202/195 B 15mm				8	15	St 154.00
Schrankband ohne Kloben	16.1202/195 15mm	83	195		8	15	St 93.00
Bolzenstützkloben	16.1202 D	16	125		8	12/15	St 41.50
Plattenstützkloben	16.1202 B	25	125	72	8	12/15	St 61.00

Schlüsselkopf

Eisen blank

Bezeichnung	Bestellnummer	H	I	Ø	CHF
Schlüsselkopf	18.1159.1	25	30	4.2	St 14.00
Schlüsselkopf	18.1159.2	29	32	4.2	St 14.00



Schlüsselkopf

Eisen blank

Bezeichnung	Bestellnummer	H	I	Ø	CHF
Schlüsselkopf	18.1160	31	40	4.2	St 14.00



Schlüssel

Eisen blank

Bezeichnung	Bestellnummer	H	I	H	H	CHF
Schlüssel	18.1164/35 VB	28	67	35	35	St 16.00
Schlüssel	18.1164/40 Euro	31	75	40	40	St 13.10



Schlüsselkopf

Eisen blank

Bezeichnung	Bestellnummer	H	I	Ø	CHF
Schlüsselkopf	18.1168	30	36	4.2	St 14.00



Schlüsselkopf

Eisen blank

Bezeichnung	Bestellnummer	H	I	Ø	CHF
Schlüsselkopf	18.1169	37	45	4.2	St 14.00



Schlüsselkopf

Eisen blank
ungebohrt

Bezeichnung	Bestellnummer	H	I	CHF
Schlüsselkopf	18.1170	45	53	St 14.00



Schrankfeder mit Haken

Eisen blank

Bezeichnung	Bestellnummer	H	I	CHF
Schrankfeder mit Haken	18.1127	120	25	St 12.50



Schliessblech

Eisen blank

Bezeichnung	Bestellnummer	H	I	H	CHF
Schliessblech flach	18.1122 F	15	75	1.5	St 9.50
Winkelschliessblech	18.1122 W	15	75	15	St 11.00



passend zu Schloss Nr. 18.1122

**Schrankschloss**

Eisen blank

Bezeichnung	Bestellnummer	H	I	H	I	CHF
Schrankschloss links	18.1122/25 Ls	50	75	17	25	St 49.00
Schrankschloss rechts	18.1122/25 Rs	50	75	17	25	St 49.00
Schrankschloss links	18.1122/30 Ls	55	75	17	30	St 49.00
Schrankschloss rechts	18.1122/30 Rs	55	75	17	30	St 49.00
Schrankschloss links	18.1122/35 Ls	60	75	17	35	St 49.00
Schrankschloss rechts	18.1122/35 Rs	60	75	17	35	St 49.00
Schrankschloss links	18.1122/40 Ls	65	75	17	40	St 53.00
Schrankschloss rechts	18.1122/40 Rs	65	75	17	40	St 53.00
Schrankschloss links	18.1122/45 Ls	70	75	17	45	St 53.00
Schrankschloss rechts	18.1122/45 Rs	70	75	17	45	St 53.00
Schrankschloss links	18.1122/50 Ls	75	75	17	50	St 56.00
Schrankschloss rechts	18.1122/50 Rs	75	75	17	50	St 56.00
Schrankschloss links	18.1122/55 Ls	80	75	17	55	St 56.00
Schrankschloss rechts	18.1122/55 Rs	80	75	17	55	St 56.00
Schlüssel	18.1122 Schlüssel					St 19.50

passende Schliessbleche: Art. 18.1122 F oder 18.1122 W

Bügelgriff Serie Latus

Bronze dunkel

Bezeichnung	Bestellnummer	H	I	H	∞	▨	CHF
Bügelgriff	80.300/096	105	13	37	96	M4	St 43.00
Bügelgriff	80.300/128	137	13	37	128	M4	St 49.00

**Muschelgriff Serie Angulum**

Bronze dunkel

Bezeichnung	Bestellnummer	H	I	H	∞	▨	CHF
Muschelgriff	80.301/096	102	24	30	96	M4	St 54.00

**Bügelgriff Serie Quadrum**

Bronze dunkel

Bezeichnung	Bestellnummer	H	I	H	∞	▨	CHF
Bügelgriff	80.310/128	139	20	31	128	M4	St 61.00
Bügelgriff	80.310/160	171	20	31	160	M4	St 85.50
Bügelgriff	80.310/384	395	20	31	384	M4	St 145.00

**Möbelknopf Serie Latus**

Bronze dunkel

Bezeichnung	Bestellnummer	H	I	H	▨	CHF
Möbelknopf	80.340/28	28	16	25	M4	St 27.00
Möbelknopf	80.340/35	35	25	34	M4	St 29.00

**Möbelknopf Serie Quadrum**

Bronze dunkel

Bezeichnung	Bestellnummer	H	I	H	▨	CHF
Möbelknopf	80.350/30	30	25	25	M4	St 33.00
Möbelknopf	80.350/40	40	30	30	M4	St 39.00

**Möbelknopf Serie Angulum**

Bronze dunkel

Bezeichnung	Bestellnummer	H	I	H	▨	CHF
Möbelknopf	80.352/25	25	25	22	M4	St 37.00
Möbelknopf	80.352/35	35	35	25	M4	St 46.00

**Möbelknopf**

Bronze dunkel

Bezeichnung	Bestellnummer	H	I	H	▨	CHF
Möbelknopf	80.360/27	27	13	28	M4	St 27.00
Möbelknopf	80.360/31	31	15	28	M4	St 29.00

**Schrankolive Serie Angulum**

Bronze dunkel

Bezeichnung	Bestellnummer	H	I	H	□	▨	CHF
Schrankolive	80.380/45 E-35	45	45	28	7x35		St 64.00
Schrankknopf	80.380/45 F	45	45	28		M4	St 59.00



**Bügelgriff Serie Latus**

Bronze versilbert



Bezeichnung	Bestellnummer	H	I	H	∅	mm	CHF
Bügelgriff	83.300/096	105	13	37	96	M4	St 61.00
Bügelgriff	83.300/128	137	13	37	128	M4	St 67.00

**Muschelgriff Serie Angulum**

Bronze versilbert



Bezeichnung	Bestellnummer	H	I	H	∅	mm	CHF
Muschelgriff	83.301/096	102	24	30	96	M4	St 79.00

**Bügelgriff Serie Quadrum**

Bronze versilbert



Bezeichnung	Bestellnummer	H	I	H	∅	mm	CHF
Bügelgriff	83.310/128	139	20	31	128	M4	St 79.00
Bügelgriff	83.310/160	171	20	31	160	M4	St 112.00
Bügelgriff	83.310/384	395	20	31	384	M4	St 180.00

**Möbelknopf Serie Latus**

Bronze versilbert



Bezeichnung	Bestellnummer	H	I	H	mm	CHF
Möbelknopf	83.340/28	28	16	25	M4	St 33.00
Möbelknopf	83.340/35	35	25	34	M4	St 35.00

**Möbelknopf Serie Quadrum**

Bronze versilbert



Bezeichnung	Bestellnummer	H	I	H	mm	CHF
Möbelknopf	83.350/30	30	25	25	M4	St 43.00
Möbelknopf	83.350/40	40	30	30	M4	St 49.00

**Möbelknopf Serie Angulum**

Bronze versilbert



Bezeichnung	Bestellnummer	H	I	H	mm	CHF
Möbelknopf	83.352/25	25	25	22	M4	St 46.00
Möbelknopf	83.352/35	35	35	25	M4	St 59.00

**Möbelknopf**

Bronze versilbert

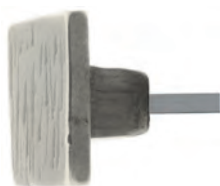

Bezeichnung	Bestellnummer	H	I	H	mm	CHF
Möbelknopf	83.360/27	27	13	28	M4	St 33.00
Möbelknopf	83.360/31	31	15	28	M4	St 37.00

**Schrankolive Serie Angulum**

Bronze versilbert



Bezeichnung	Bestellnummer	H	I	H	∅	mm	CHF
Schrankolive	83.380/45 E-35	45	45	28	7x35		St 83.00
Schrankknopf	83.380/45 F	45	45	28		M4	St 78.00

Eisen naturblank
Eisen vibropatiniert®
Eisen gerostet
Eisen blank

Seite 9.02
Seite 9.02
Seite 9.03
Seite 9.04

Holzschrauben



Eisen naturblank
Eisen verzinkt-allpatiniert
Eisen gerostet

Seite 9.02
Seite 9.02
Seite 9.04

Zylinder/Schlüssel/Schlösser

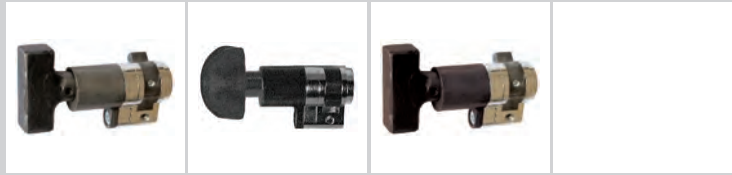

Eisen naturblank
Eisen verzinkt-allpatiniert

Seite 9.02
Seite 9.03

Diverses

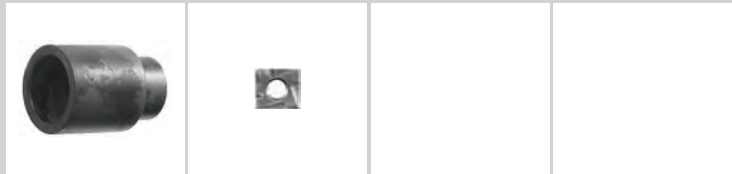

**Kugelnagel**

Eisen naturblank

Bezeichnung	Bestellnummer	I	Ø	☒	CHF
Kugelnagel	60.4277.13	25	8	10/10	St 8.20

**Kugelschraube**

Eisen naturblank

Bezeichnung	Bestellnummer	Ø	☒	CHF
Kugelschraube	60.4278.13 08x20mm	8	10/10	St 9.10
Kugelschraube	60.4278.13 10x30mm	10	10/10	St 9.40
Kugelschraube	60.4278.13 13x40mm	13	10/10	St 10.30

**Drehknopfzylinder 90°**

Eisen naturblank

Bezeichnung	Bestellnummer	H	I	Ø	CHF
Drehknopfzylinder 90°	60.3201.13	40	35	22	St 165.00

**Drehknopfzylinder 90°**

Eisen naturblank

Bezeichnung	Bestellnummer	H	I	Ø	CHF
Drehknopfzylinder 90°	60.3203.13	40	35	22	St 165.00

**Drehknopf für Zylinder**

Eisen naturblank

passend zu Drehknopfzylindern von Kaba und Keso

Bezeichnung	Bestellnummer	H	H	Ø	☒	CHF
Drehknopf für Zylinder	60.3208.13 Kaba	30	25		M4	St 35.00
Drehknopf für Zylinder	60.3208.13 Keso	30	25	7	M4	St 29.50

**Drückerverlängerung**

Eisen naturblank

Bezeichnung	Bestellnummer	H	I	Ø	CHF
Drückerverlängerung	60.2950.13 18x25	35	24	18	St 22.50

**Ziermutter**

Eisen naturblank

Bezeichnung	Bestellnummer	CHF
Ziermutter	60.4286.13 M05	St 10.50
Ziermutter	60.4286.13 M06	St 10.50
Ziermutter	60.4286.13 M08	St 12.50
Ziermutter	60.4286.13 M10	St 14.00

**Schlüsselschraube**

Eisen vibropatiniert®

Bezeichnung	Bestellnummer	CHF
Schlüsselschraube	60.4285.14 8x40	St 3.00
Schlüsselschraube	60.4285.14 8x50	St 3.00
Schlüsselschraube	60.4285.14 8x60	St 3.00

**Drehknopfzylinder 90°**

Eisen verzinkt-altpatiniert

Bezeichnung	Bestellnummer	H	I	Ø	CHF
Drehknopfzylinder 90°	60.3201.15	40	35	22	St 180.00

Drehknopfzylinder 90°

Eisen verzinkt-altpatiniert

Bezeichnung	Bestellnummer	H	I	Ø	CHF
Drehknopfzylinder 90°	60.3203.15	40	35	22	St 180.00

**Drehknopf für Zylinder**

Eisen verzinkt-altpatiniert

passend zu Drehknopfzylindern von Kaba und Keso

Bezeichnung	Bestellnummer	H	I	Ø	mm	CHF
Drehknopf für Zylinder	60.3208.15 Kaba	30	25		M4	St 42.50
Drehknopf für Zylinder	60.3208.15 Keso	30	25	7	M4	St 37.00

**Drückerverlängerung**

Eisen verzinkt-altpatiniert

Bezeichnung	Bestellnummer	H	I	Ø	CHF
Drückerverlängerung	60.2950.15 18x25	35	24	18	St 22.50

**Halbrundkopfschraube**

Eisen gerostet

Bezeichnung	Bestellnummer	mm	CHF
Halbrundkopfschraube	60.1982.16 2.5x16	200/20	St 0.60
Halbrundkopfschraube	60.1982.16 3.0x20	200/20	St 0.65
Halbrundkopfschraube	60.1982.16 3.5x20	200/20	St 0.65
Halbrundkopfschraube	60.1982.16 4.0x25	200/20	St 0.95
Halbrundkopfschraube	60.1982.16 4.5x30	200/20	St 1.15
Halbrundkopfschraube	60.1982.16 5.0x30	200/20	St 1.15
Halbrundkopfschraube	60.1982.16 5.0x40	200/20	St 1.20
Halbrundkopfschraube	60.1982.16 5.0x50	200/20	St 1.30
Halbrundkopfschraube	60.1982.16 6.0x30	200/20	St 1.30
Halbrundkopfschraube	60.1982.16 6.0x40	200/20	St 1.40
Halbrundkopfschraube	60.1982.16 6.0x50	200/20	St 1.50

**Linsensenkschraube**

Eisen gerostet

Bezeichnung	Bestellnummer	mm	CHF
Linsensenkschraube	60.1983.16 3.0x20	200/20	St 0.65
Linsensenkschraube	60.1983.16 3.5x20	200/20	St 0.70
Linsensenkschraube	60.1983.16 4.0x20	200/20	St 0.90
Linsensenkschraube	60.1983.16 4.0x25	200/20	St 0.95

**Senk-Holzschraube**

Eisen gerostet

Bezeichnung	Bestellnummer	mm	CHF
Senk-Holzschraube	60.1984.16 3.5x16	200/20	St 0.60
Senk-Holzschraube	60.1984.16 3.5x20	200/20	St 0.65
Senk-Holzschraube	60.1984.16 4.5x25	200/20	St 0.80

**Schlüsselschraube**

Eisen gerostet

Bezeichnung	Bestellnummer	mm	CHF
Schlüsselschraube	60.4285.16 8x40		St 3.35
Schlüsselschraube	60.4285.16 8x50		St 3.35
Schlüsselschraube	60.4285.16 8x60		St 3.35



**Drehknopfzylinder 90°**

Eisen gerostet

Bezeichnung	Bestellnummer	H	I	Ø	CHF
Drehknopfzylinder 90°	60.3201.16	40	35	22	St 185.00

**Drehknopfzylinder 90°**

Eisen gerostet

Bezeichnung	Bestellnummer	H	I	Ø	CHF
Drehknopfzylinder 90°	60.3203.16	40	35	22	St 185.00

**Drehknopf für Zylinder**

Eisen gerostet

passend zu Drehknopfzylindern von Kaba und Keso

Bezeichnung	Bestellnummer	H	I	Ø	mm	CHF
Drehknopf für Zylinder	60.3208.16 Kaba	30	25		M4	St 42.50
Drehknopf für Zylinder	60.3208.16 Keso	30	25	7	M4	St 37.00

**Schlossnagel**

Eisen blank

Bezeichnung	Bestellnummer	CHF
Schlossnagel	60.4275.18/30 mm	St 0.40
Schlossnagel	60.4275.18/40 mm	St 0.60
Schlossnagel	60.4275.18/50 mm	St 0.80
Schlossnagel	60.4275.18/60 mm	St 1.10
Schlossnagel	60.4275.18/70 mm	St 1.30

**Bandnagel**

Eisen blank

Bezeichnung	Bestellnummer	CHF
Bandnagel	60.4279.18/040 mm	St 0.50
Bandnagel	60.4279.18/050 mm	St 0.60
Bandnagel	60.4279.18/060 mm	St 0.80
Bandnagel	60.4279.18/070 mm	St 1.10
Bandnagel	60.4279.18/080 mm	St 1.30
Bandnagel	60.4279.18/100 mm	St 1.90